



2025

fiyat listesi

O C A K

TBLOC 2020 yılının Ocak ayında İzmir’de kurulmuş bir endüstri firmasıdır. Yeni bir firma olmasına rağmen kökleri uzun yıllara dayanan tecrübe ve birikimler nedeniyle çok derindedir. TBLOC, Türkiye’nin yeni bağlantı elemanları markası olarak Ar-Ge, Üretim ve Satış faaliyetlerini tek çatı altında yürütmekte ve bir Türk markası olarak uluslararası standartlarda ürettiği ürünleri tüm dünyaya ihraç etmektedir.

TBLOC markası, klemensin İngilizce karşılığı olan Terminal Block kelimelerinin bir kısaltması olarak görünse de “t” harfi teknolojinin kısaltması olarak markamızın başında, şirketimizin uzun vadeli planlarının göstergesi olarak yerini almıştır.

Tbloc Kurumsal

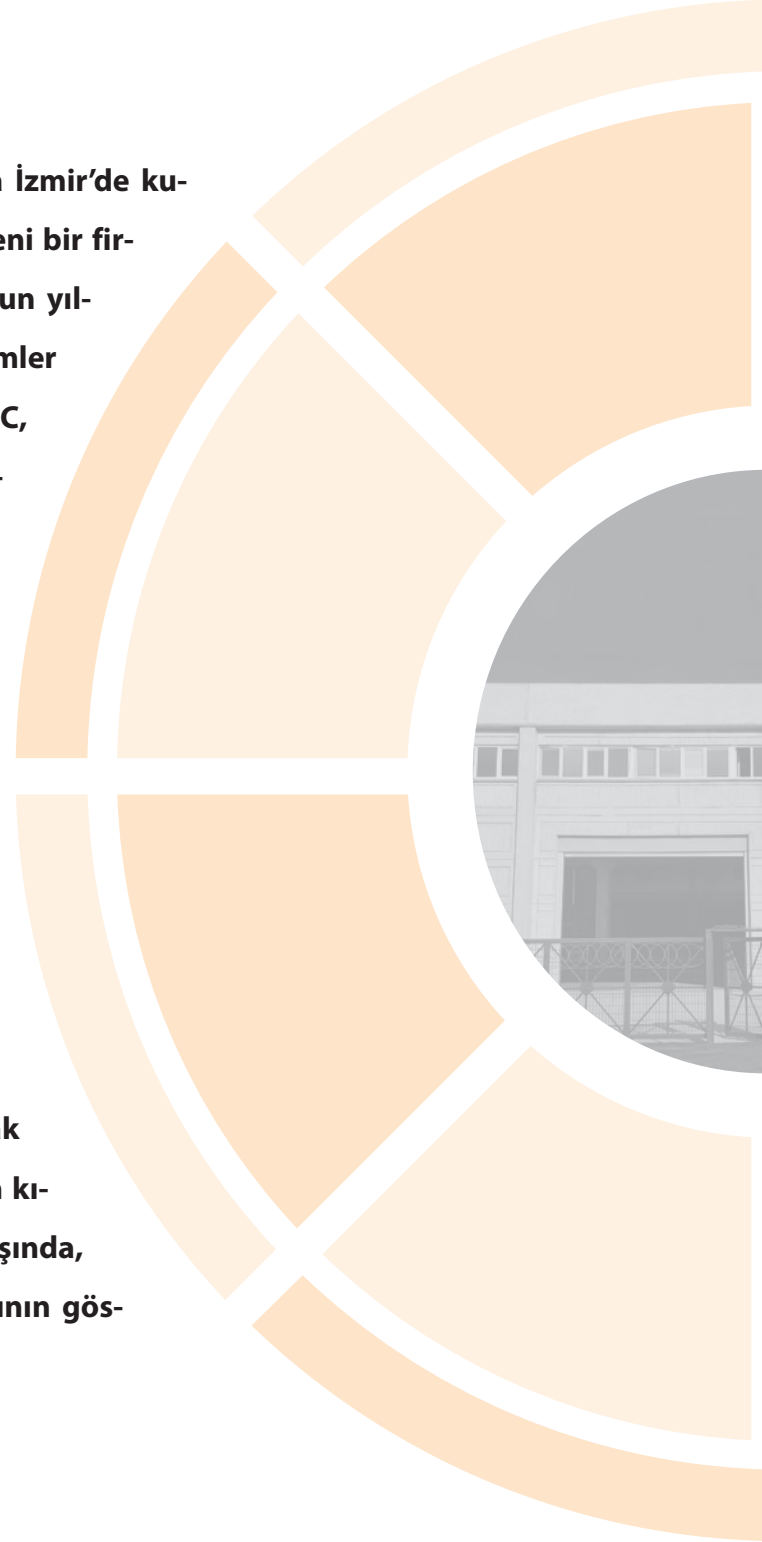



TBLOC is an industrial company established in January 2020 in İzmir/Turkey. Even though TBLOC is a new company, it has deep roots backed up with long years experience and knowledge. TBLOC, as a new brand in connectivity industry, is gathering all R&D, production and sales & marketing functions under one roof with the aim of becoming a global brand and supplying to international markets.

Despite TBLOC brand is being perceived as an abbreviation of Terminal Block definition, first letter "t" stands for technology and indicates our company's long term vision.

Tbloc Corporate

İçindekiler / Contents

● Klemensler ve Aksesuarları Terminal Blocks and Accessories	6 - 24
● Klemens Etiketleri Marking Tags	25 - 28
● Klemens Aksesuar Seçim Tablosu Terminal Blocks Accessories Selection Table	29 - 35
● Montaj Rayları ve Aksesuarları Mounting Rails and Accessories	36 - 37
● Dağıtım Blokları Distribution Blocks	38 - 39
● Müşterek W Otomat Baraları PIN MCB Busbars	40
● Kablo Kanalları Wiring Ducts	41 - 42
● Markalama Sistemleri Marking Systems	43 - 49
● Kablo Bağları, Kroşeler ve Paslanmaz Çelik Kablo Bağları - 304 Kalite Cable Ties, Tie Mounts and Stainless Steel Cable Ties	51 - 53
● Sıkmalı Kablo Pabuçları Compression Cable Lugs	54 - 55
● İzoleli ve İzolesiz Kablo Yüksükleri - İzoleli Kablo Pabuçları Insulated and Non-Insulated End Sleeves - Insulated Cable Terminals	56 - 63
● Ledli Sinyal Lambaları ve Kumanda Butonları Led Indicators and Push Buttons	64 - 70
● Endüstriyel ve PLC Röleler Industrial and PLC Relays	71 - 77

Genel Şartlar

- Fiyatlara K.D.V. dahil değildir.
- Fiyat listemiz 13 OCAK 2025 tarihinden itibaren geçerli olan liste fiyatlarımızı içerir.
- Teslim anındaki fiyatlar geçerlidir.
- Önceden haber vermeksizin fiyat değiştirme hakkımız saklıdır.
- Sevkiyatlar standart ambalaja göre yapılır.
- Aksi bildirilmedikçe nakliye bedeli alıcıya aittir.
- Tbloc firmasının yazılı onayı olmadan iade kabul edilmeyecektir.
- Ürünlerimizde değişiklik yapma hakkımız saklıdır.
- İçeride görülen resim ve teknik değerler genel bilgi amaçlıdır.
- Listemizde bulamadığınız ürünler için lütfen satış birimimizle temasa geçiniz.

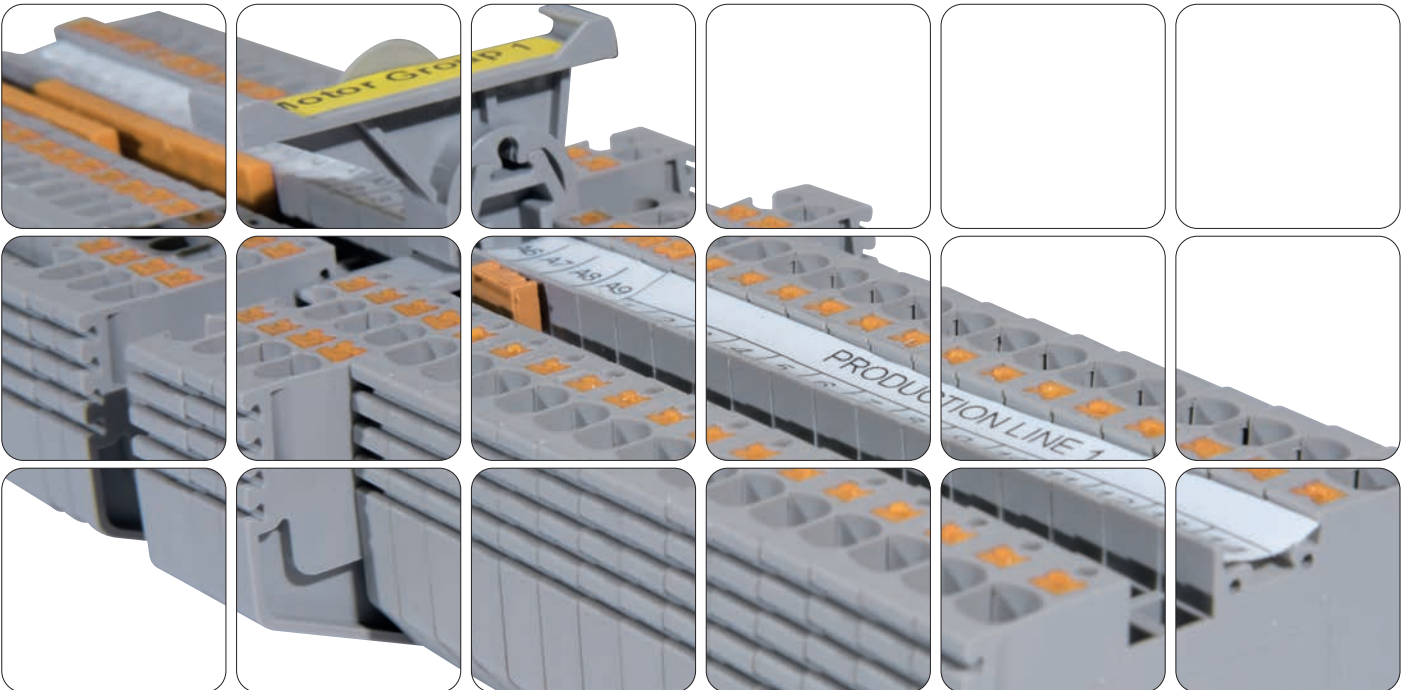

NTB

Geçiş Klemensleri
Çok Katlı Klemensler
Sigortalı ve Ayırmalı Klemensler
Topraklama Klemensleri

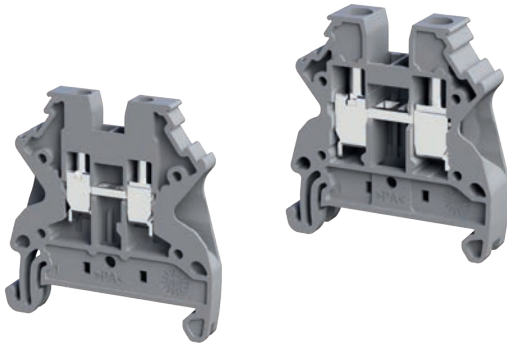
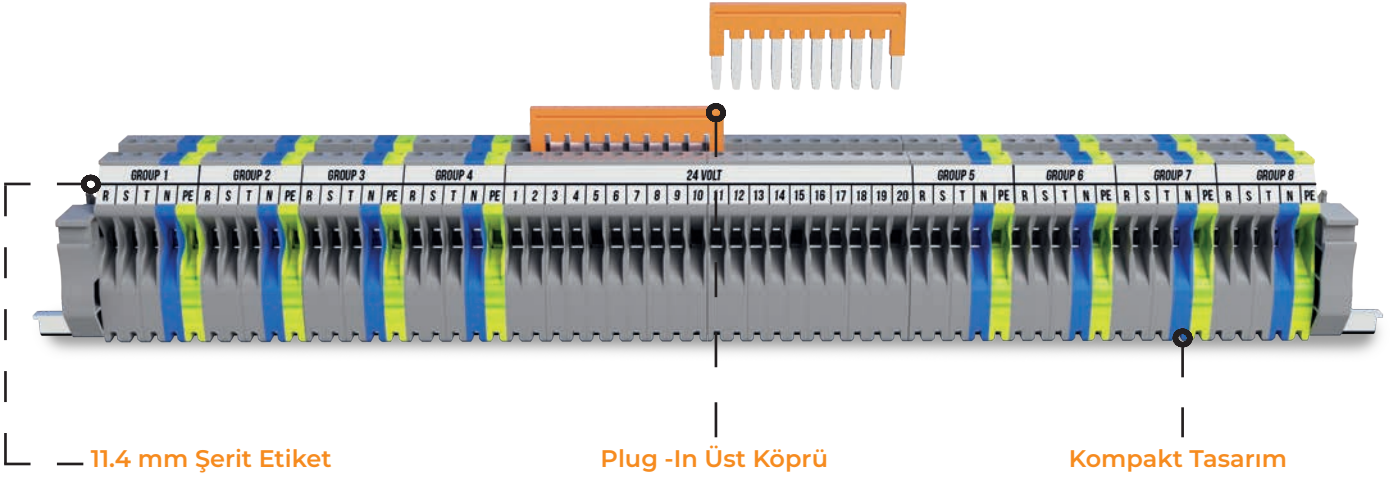

NTB 2,5

NTB 10



NTB Serisi Geçiş Klemensleri

NTB Series Feed Through Terminal Block

Ürün Kodu Product Code	Ürün Adı Product Name	Açıklama Explanation	Kesit Cross Sec. (mm ²)	Renk Color	Amb. Mik. Pack. Qty (Adet/Pcs.)	Koli Mik. Box.Qty. (Adet/Pcs.)	Birim Fiyatı Unit Price (TL/Adet)
8000099208	NTB 2,5	Geçiş Klemensi / Feed Through Terminal Block	2,5	Gri / Grey	100	1.000	27,950
8000099308	NTB 4	Geçiş Klemensi / Feed Through Terminal Block	4	Gri / Grey	85	850	32,500
8000099408	NTB 6	Geçiş Klemensi / Feed Through Terminal Block	6	Gri / Grey	65	650	45,500
8000099508	NTB 10	Geçiş Klemensi / Feed Through Terminal Block	10	Gri / Grey	50	500	58,500

Renk Kodları / Color Codes

800009900...

...0

...1

...2

...3

...4

...5

...6

...9

*Farklı renklerdeki klemens siparişlerinizi yukarıdaki renk skalasında verilen kodlara uygun olarak oluşturabilirsiniz.

**NTB serisi klemenslerin üst köprülerini seçmek için Sayfa 22'ye bakabilirsiniz.

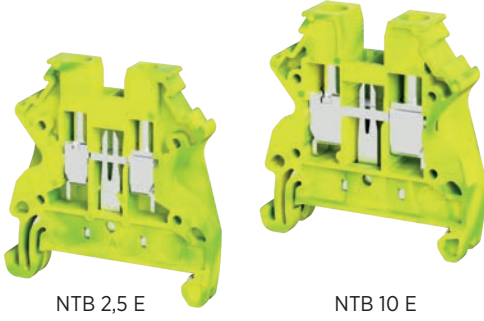

NTB 2,5 E

NTB 10 E



Vida Bağlantılı Topraklama Klemensleri

Screw Connection Earth Terminal Block

Ürün Kodu Product Code	Ürün Adı Product Name	Açıklama Explanation	Kesit Cross Sec. (mm ²)	Renk Color	Amb. Mik. Pack. Qty (Adet/Pcs.)	Koli Mik. Box.Qty. (Adet/Pcs.)	Birim Fiyatı Unit Price (TL/Adet)
8001099304	NTB 2,5 E	Topraklama Klemensi / Earth Terminal Blocks	2,5	Sarı-Yeşil / Yellow-Green	70	1400	113,000
8001099314	NTB 4 E	Topraklama Klemensi / Earth Terminal Blocks	4	Sarı-Yeşil / Yellow-Green	60	900	130,000
8001099324	NTB 6 E	Topraklama Klemensi / Earth Terminal Blocks	6	Sarı-Yeşil / Yellow-Green	45	720	169,000
8001099334	NTB 10 E	Topraklama Klemensi / Earth Terminal Blocks	10	Sarı-Yeşil / Yellow-Green	35	560	195,000

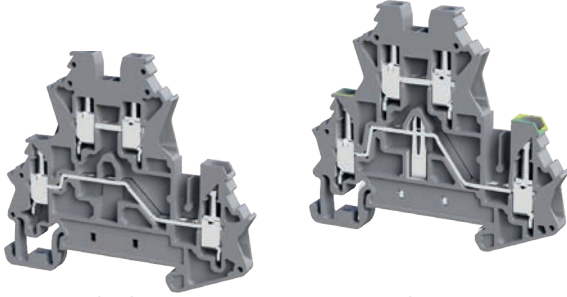

NTB 2,5 2P

NTB 2,5 P + E



NTB Serisi Çok Katlı Klemensler

NTB Series Multilevel Terminal Blocks

Ürün Kodu Product Code	Ürün Adı Product Name	Açıklama Explanation	Kesit Cross Sec. (mm ²)	Renk Color	Amb. Mik. Pack. Qty (Adet/Pcs.)	Koli Mik. Box.Qty. (Adet/Pcs.)	Birim Fiyatı Unit Price (TL/Adet)
8002099558	NTB 2,5 2P	2 katlı geçiş klemensi 2 levels feed through terminal blocks	2,5	Gri / Grey	30	600	84,500
8002099556	NTB 2,5 2P	2 katlı geçiş klemensi 2 levels feed through terminal blocks	2,5	Mavi / Blue	30	600	84,500
8002099568	NTB 2,5 P + E	1 katı geçiş, 1 katı topraklama klemensi 1 level feed through, 1 level earth terminal blocks	2,5	Gri / Grey	30	600	182,000

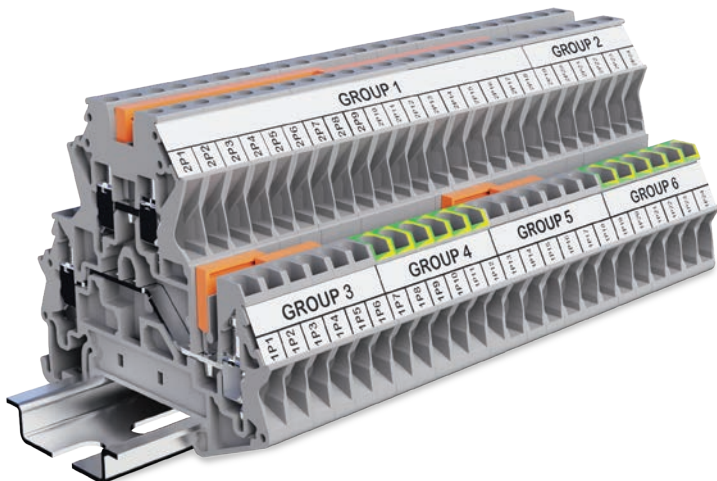

- Her katta çift kanallı pratik üst köprüleme
- Her katta 11.4 mm şerit etiket ile markalama
- Kompakt tasarım

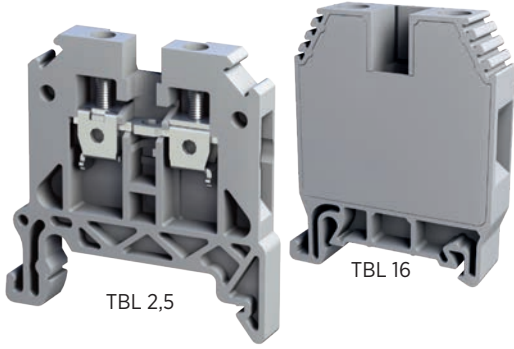

TBL Serisi Geçiş Klemensleri

TBL Series Feed Through Terminal Block

Ürün Kodu Product Code	Ürün Adı Product Name	Açıklama Explanation	Kesit Cross Sec. (mm ²)	Renk Color	Amb. Mik. Pack. Qty (Adet/Pcs.)	Koli Mik. Box.Qty. (Adet/Pcs.)	Birim Fiyatı Unit Price (TL/Adet)
8000099008	TBL 2,5	Geçiş Klemensi / Feed Through Terminal Block	2,5	Gri / Grey	100	1.000	26,600
8000099028	TBL 4	Geçiş Klemensi / Feed Through Terminal Block	4	Gri / Grey	100	1.000	31,500
8000099038	TBL 6	Geçiş Klemensi / Feed Through Terminal Block	6	Gri / Grey	80	1.200	44,800
8000099048	TBL 10	Geçiş Klemensi / Feed Through Terminal Block	10	Gri / Grey	60	900	57,400
8000099058	TBL 16	Geçiş Klemensi / Feed Through Terminal Block	16	Gri / Grey	50	500	89,110
8000099068	TBL 25	Geçiş Klemensi / Feed Through Terminal Block	25	Gri / Grey	50	500	143,640
8000099078	TBL 35	Geçiş Klemensi / Feed Through Terminal Block	35	Gri / Grey	20	320	183,540
8000099088	TBL 50	Geçiş Klemensi / Feed Through Terminal Block	50	Gri / Grey	20	200	465,500

Renk Kodları / Color Codes

800009900.... ...0 ...1 ...2 ...3 ...4 ...5 ...6 ...9

*Farklı renklerdeki klemens siparişlerinizi yukarıdaki renk skalasında verilen kodlara uygun olarak oluşturabilirsiniz.

**TBL serisi klemenslerin üst köprülerini seçmek için Sayfa 16'ya bakabilirsiniz açıklamasını ekleyelim.

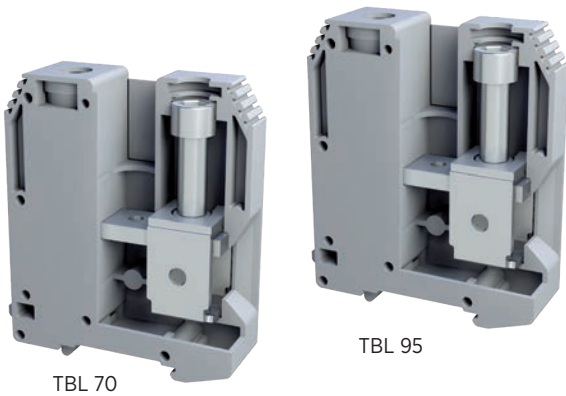

8000099098	TBL 70	Geçiş Klemensi / Feed Through Terminal Block	70	Gri / Grey	10	50	638,400
8000099096	TBL 70	Geçiş Klemensi / Feed Through Terminal Block	70	Mavi / Blue	10	50	638,400
8000099108	TBL 95	Geçiş Klemensi / Feed Through Terminal Block	95	Gri / Grey	5	50	831,250
8000099106	TBL 95	Geçiş Klemensi / Feed Through Terminal Block	95	Mavi / Blue	5	50	831,250
8000099118	TBL 150	Geçiş Klemensi / Feed Through Terminal Block	150	Gri / Grey	5	50	1079,000
8000099116	TBL 150	Geçiş Klemensi / Feed Through Terminal Block	150	Mavi / Blue	5	50	1079,000

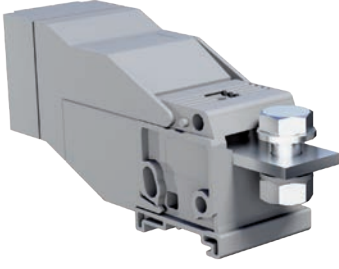

TBB 70



C-TBB 70-95-150



Yüksek Akım Klemensi

High Current Terminal Blocks

Ürün Kodu Product Code	Ürün Adı Product Name	Açıklama Explanation	Kesit Cross Sec. (mm ²)	Renk Color	Amb. Mik. Pack. Qty (Adet/Pcs.)	Koli Mik. Box.Qty. (Adet/Pcs.)	Birim Fiyatı Unit Price (TL/Adet)
8000099128	TBB 70	Yüksek Akım Klemensi / High Current Terminal Blocks	70	Gri / Grey	5	50	784,700
8000099138	TBB 95	Yüksek Akım Klemensi / High Current Terminal Blocks	95	Gri / Grey	5	50	837,900
8000099148	TBB 150	Yüksek Akım Klemensi / High Current Terminal Blocks	150	Gri / Grey	5	50	1.130,500
8000099158	TBB 240	Yüksek Akım Klemensi / High Current Terminal Blocks	240	Gri / Grey	4	40	1.755,000

Koruma Kapakları / Isolation Covers

8012396608	C-TBB 70-95-150	Koruma Kapağı / Isolation Cover	70-150	Gri / Grey	10	150	162,500
8012396618	C-TBB 240	Koruma Kapağı / Isolation Cover	240	Gri / Grey	8	150	206,700

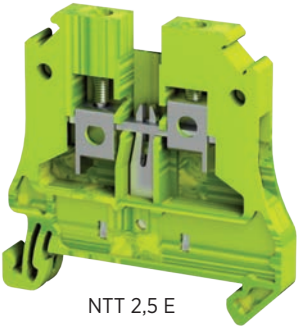

NTT 2,5 E







TBL 16 E



Vida Bağlantılı Topraklama Klemensleri

Screw Connection Earth Terminal Block

Ürün Kodu Product Code	Ürün Adı Product Name	Açıklama Explanation	Kesit Cross Sec. (mm ²)	Renk Color	Amb. Mik. Pack. Qty (Adet/Pcs.)	Koli Mik. Box.Qty. (Adet/Pcs.)	Birim Fiyatı Unit Price (TL/Adet)
8001099214	NTT 2,5 E 	Topraklama Klemensi / Earth Terminal Blocks	2,5	Sarı-Yeşil / Yellow-Green	50	500	100,100
8001099224	NTT 4 E 	Topraklama Klemensi / Earth Terminal Blocks	4	Sarı-Yeşil / Yellow-Green	50	500	114,400
8001099234	NTT 6 E 	Topraklama Klemensi / Earth Terminal Blocks	6	Sarı-Yeşil / Yellow-Green	25	500	152,100
8001099244	NTT 10 E 	Topraklama Klemensi / Earth Terminal Blocks	10	Sarı-Yeşil / Yellow-Green	20	400	178,100
8001099194	TBL 16 E	Topraklama Klemensi / Earth Terminal Blocks	16	Sarı-Yeşil / Yellow-Green	20	340	243,100
8001099204	TBL 35 E	Topraklama Klemensi / Earth Terminal Blocks	35	Sarı-Yeşil / Yellow-Green	20	200	465,500

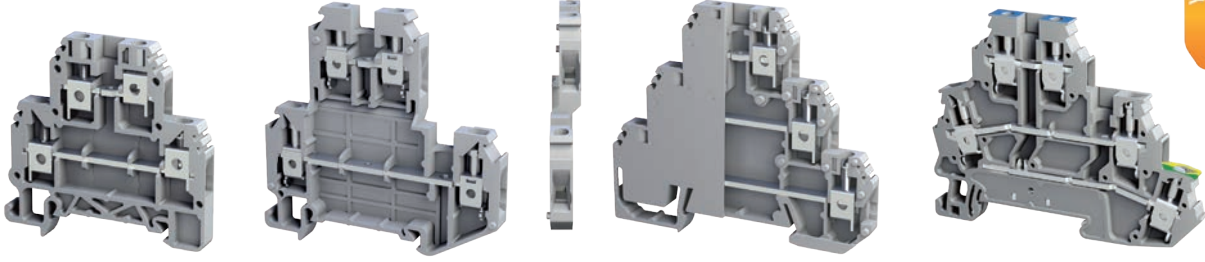

TBL 2,5-4 2P

TBL 4 2P

TBL 4 3P

TBL 2,5 2P+E



Vida Bağlantılı Çok Katlı Klemensler

Screw Type Multilevel Terminal Blocks

Ürün Kodu Product Code	Ürün Adı Product Name	Açıklama Explanation	Kesit Cross Sec. (mm ²)	Renk Color	Amb. Mik. Pack. Qty (Adet/Pcs.)	Koli Mik. Box.Qty. (Adet/Pcs.)	Birim Fiyatı Unit Price (TL/Adet)
8002099438	TBL 2,5-4 2P	2 katlı geçiş klemensi 2 levels feed through terminal blocks	2,5 - 4	Gri / Grey	50	600	76,700
8002099258	TBL 4 2P	2 katlı geçiş klemensi 2 levels feed through terminal blocks	4	Gri / Grey	50	800	94,900
8002099488	TBL 10 2P	2 katlı geçiş klemensi 2 levels feed through terminal blocks	10	Gri / Grey	25	300	221,000
8002099478	TBL 4 3P	3 katlı geçiş / 3 levels feed through	4	Gri / Grey	25	500	182,000
8002099158	TBL 2,5 - 2P+E	Çok katlı + topraklama klemensi Multi levels + earth terminal blocks	2,5	Gri / Grey	35	-	195,000

Renk Kodları / Color Codes

800009900...

...0	...1	...2	...3	...4	...5	...6	...9
------	------	------	------	------	------	------	------

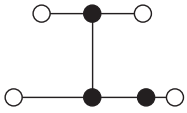

8002099428
TBL 4 2PK

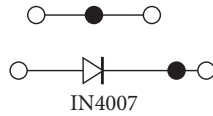

8002099268
TBL 4 2P X1

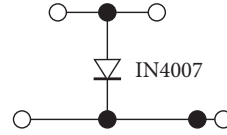

8002099278
TBL 4 2P X2

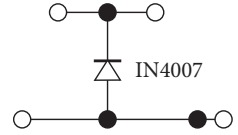

8002099288
TBL 4 2P X3

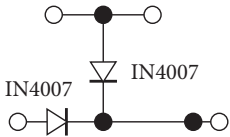

8002099298
TBL 4 2P X4

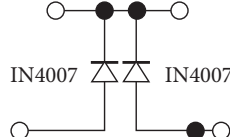

8002099305 **TBL 4 2P X5**
8002099318
TBL 4 2P X5 Gri

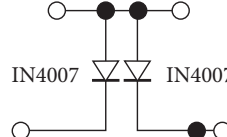

8002099328
TBL 4 2P X6

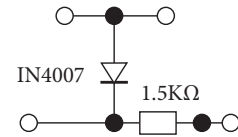

8002099348
TBL 4 2P X8

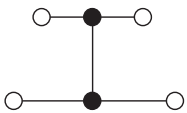

8002099448
TBL 2,5-4 2PK

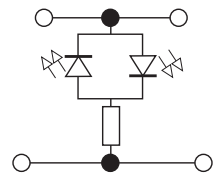

8002099458
TBL 2,5-4 2PL (24-48VAC/DC) Gri
8002099468
TBL 2,5-4 2PL (110-220VAC/DC) Gri

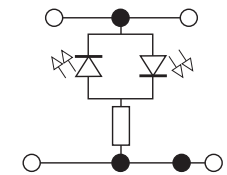

8002099368
TBL 4 2PL (24-48VAC/DC) Gri
8002099378
TBL 4 2PL (110-220VAC/DC) Gri

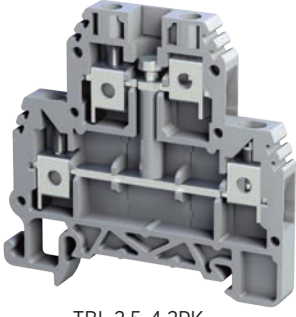

TBL 2,5-4 2PK



TBL 4 2P X1



Vida Bağlantılı Çok Katlı Klemensler

Screw Type Multilevel Terminal Blocks

Ürün Kodu Product Code	Ürün Adı Product Name	Açıklama Explanation	Kesit Cross Sec. (mm ²)	Renk Color	Amb. Mik. Pack. Qty (Adet/Pcs.)	Koli Mik. Box.Qty. (Adet/Pcs.)	Birim Fiyatı Unit Price (TL/Adet)
8002099448	TBL 2,5-4 2PK	2 katlı içeriden köprülü 2 levels internally bridged	2,5 - 4	Gri / Grey	50	600	169,000
8002099458	TBL 2,5-4 2PL(24-48VAC/DC)	2 katlı ledli ve diyotlu 2 levels with led and diode	2,5 - 4	Gri / Grey	50	600	253,500
8002099468	TBL 2,5-4 2PL(110-220VAC/DC)	2 katlı ledli ve diyotlu 2 levels with led and diode	2,5 - 4	Gri / Grey	50	600	253,500
8002099268	TBL 4 2P X1	2 katlı diyotlu 2 levels with diode	4	Gri / Grey	50	800	195,000
8002099278	TBL 4 2P X2	2 katlı diyotlu 2 levels with diode	4	Gri / Grey	50	800	195,000
8002099288	TBL 4 2P X3	2 katlı diyotlu 2 levels with diode	4	Gri / Grey	50	800	195,000
8002099298	TBL 4 2P X4	2 katlı diyotlu 2 levels with diode	4	Gri / Grey	50	800	195,000
8002099318	TBL 4 2P X5	2 katlı diyotlu 2 levels with diode	4	Gri / Grey	50	800	195,000
8002099305	TBL 4 2P X5	2 katlı diyotlu 2 levels with diode	4	Yeşil / Green	50	800	195,000
8002099328	TBL 4 2P X6	2 katlı diyotlu 2 levels with diode	4	Gri / Grey	50	800	195,000
8002099338	TBL 4 2P X7	2 katlı diyotlu 2 levels with diode	4	Gri / Grey	50	800	195,000
8002099348	TBL 4 2P X8	2 katlı diyotlu 2 levels with diode	4	Gri / Grey	50	800	195,000
8002099368	TBL 4 2PL(24-48VAC/DC)	2 katlı ledli ve diyotlu 2 levels with led and diode	4	Gri / Grey	50	800	305,50
8002099378	TBL 4 2PL(110-220VAC/DC)	2 katlı ledli ve diyotlu 2 levels with led and diode	4	Gri / Grey	50	800	305,500
8002099428	TBL 4 2PK	2 katlı içeriden köprülü 2 levels internally bridged	4	Gri / Grey	50	800	195,000



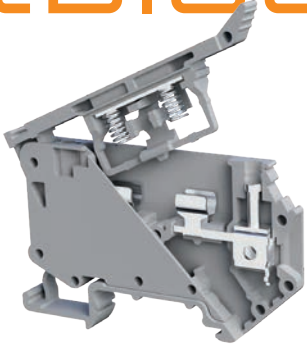

FDT 4 L



TBL 2,5 S



NTB 4 P+F



Vida Bağlantılı Sigortalı ve Bıçaklı Ayırma Klemensleri

Screw Type Fuse and Disconnect Terminal Blocks

Ürün Kodu Product Code	Ürün Adı Product Name	Açıklama Explanation	Kesit Cross Sec. (mm ²)	Renk Color	Amb. Mik. Pack. Qty (Adet/Pcs.)	Koli Mik. Box.Qty. (Adet/Pcs.)	Birim Fiyatı Unit Price (TL/Adet)
8003099488	FDT 4	Sigortalı Ayırma Klemensi Fuse and Disconnect Terminal	4	Gri / Grey	25	500	136,500
8003099486	FDT 4	Sigortalı Ayırma Klemensi Fuse and Disconnect Terminal	4	Gri / Grey	25	500	136,500
8003099498	FDT 4 L (24-48 VAC/DC)	Sigortalı Ayırma Klemensi Fuse and Disconnect Terminal	4	Gri / Grey	25	500	325,000
8003099508	FDT 4 L (110-220 VAC/DC)	Sigortalı Ayırma Klemensi Fuse and Disconnect Terminal	4	Gri / Grey	25	500	325,000
8003099496	FDT 4 L (24-48 VAC/DC)	Sigortalı Ayırma Klemensi Fuse and Disconnect Terminal	4	Mavi / Blue	25	500	325,000
8003099506	FDT 4 L (110-220 VAC/DC)	Sigortalı Ayırma Klemensi Fuse and Disconnect Terminal	4	Mavi / Blue	25	500	325,000
8003098008	NTB 4 P+F Gri	Sigortalı Ayırma Klemensi Fuse and Disconnect Terminal	4	Gri / Grey	25	500	195,000
8003098018	NTB 4 P+F Gri (24-48 VAC/DC) Gri	Sigortalı Ayırma Klemensi Fuse and Disconnect Terminal	4	Gri / Grey	25	500	445,000
8003098028	NTB 4 P+F Gri (110-220 VAC/DC)Gri	Sigortalı Ayırma Klemensi Fuse and Disconnect Terminal	4	Gri / Grey	25	500	445,000
8003098038	NTB 4 P+F Gri (110-220VAC) Gri	Sigortalı Ayırma Klemensi Fuse and Disconnect Terminal	4	Gri / Grey	25	500	445,000
8003099528	TBL 2,5 S	Ayırma Klemensi Disconnect Terminal	2,5	Gri / Grey	50	900	117,000

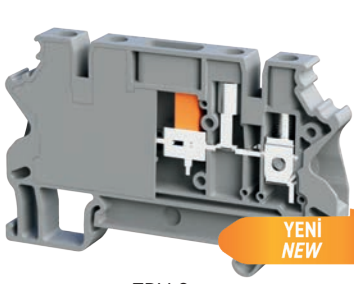

TDV 6

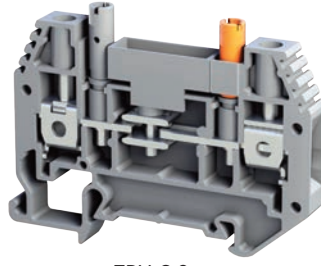

TDY-C 6

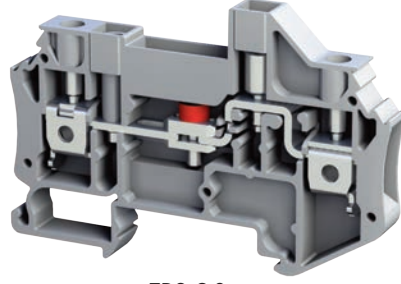





TDS-C 6



Vidalı Ölçme Ayırma Klemensleri

Screw Type Test and Disconnect Terminal Blocks

Ürün Kodu Product Code	Ürün Adı Product Name	Açıklama Explanation	Kesit Cross Sec. (mm ²)	Renk Color	Amb. Mik. Pack. Qty (Adet/Pcs.)	Koli Mik. Box.Qty. (Adet/Pcs.)	Birim Fiyatı Unit Price (TL/Adet)
8004099878	TDV-6 	Ölçme Ayırma Klemensi Test and Disconnect Terminal	6	Gri / Grey	25	500	255,000
8004099808	TDT-C 6 	Ölçme Ayırma Klemensi Test and Disconnect Terminal	6	Gri / Grey	20	320	260,000
8004099818	TDT-V 6	Ölçme Ayırma Klemensi Test and Disconnect Terminal	6	Gri / Grey	20	320	260,000
8004099828	TDS-C 6 	Ölçme Ayırma Klemensi Test and Disconnect Terminal	6	Gri / Grey	25	500	240,500
8004099838	TDV-C 6	Ölçme Ayırma Klemensi Test and Disconnect Terminal	6	Gri / Grey	25	500	240,500
8004099848	TDS-V 6 	Ölçme Ayırma Klemensi Test and Disconnect Terminal	6	Gri / Grey	25	500	240,500
8004099858	TDY-C 6	Ölçme Ayırma Klemensi Test and Disconnect Terminal	6	Gri / Grey	25	500	260,000

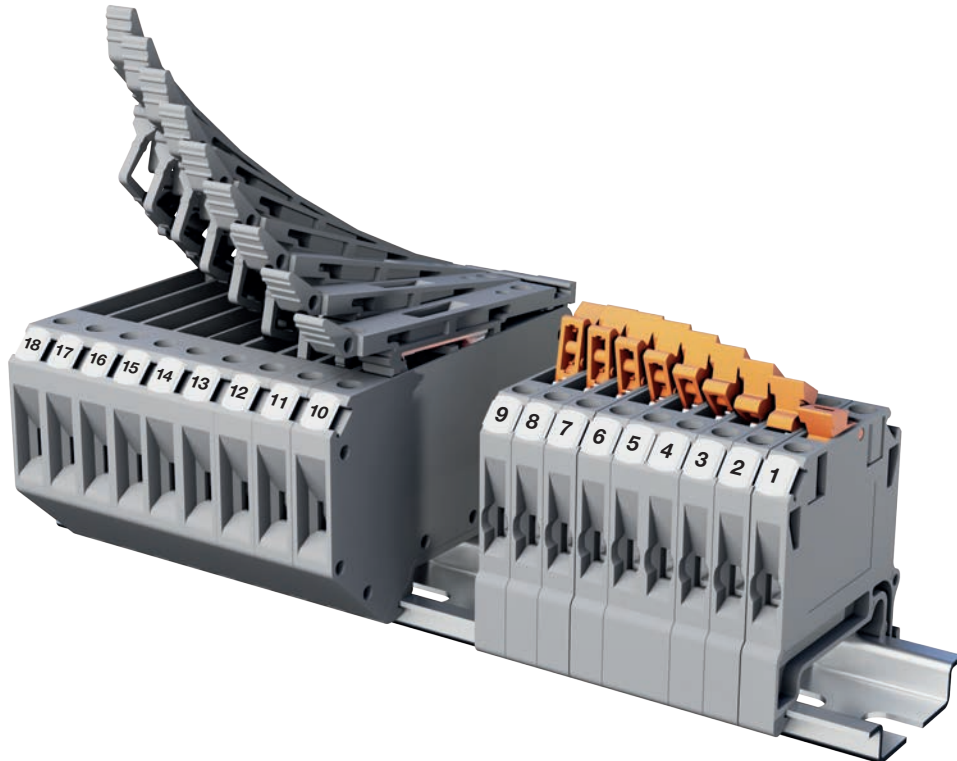

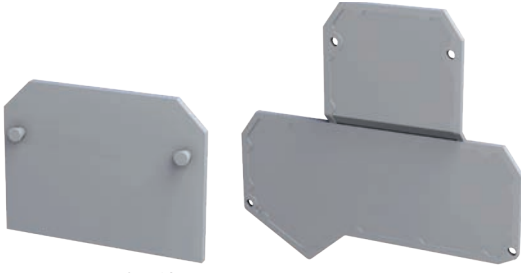

EPL TBL 2,5-10

EPL2 TBL 4 2P

Nihayet Plakaları

End Plates

Ürün Kodu Product Code	Ürün Adı Product Name	Açıklama Explanation	Kesit Cross Sec. (mm ²)	Renk Color	Amb. Mik. Pack. Qty (Adet/Pcs.)	Birim Fiyatı Unit Price (TL/Adet)
8012396288	EPL NTB 2,5-10	Nihayet Plakası / End Plate	2,5 - 10	Gri / Grey	50	19,500
8012396284	EPL NTB 2,5-10	Nihayet Plakası / End Plate	2,5 - 10	Sarı-Yeşil Green - Yellow	50	19,500
8012396388	EPL NTB 2,5- 4 2P, EPL NTB 2,5 P + E	Nihayet Plakası / End Plate	2,5 - 4	Gri / Grey	20	39,000
8012396118	EPL TBL 2,5-10	Nihayet Plakası / End Plate	2,5 - 10	Gri / Grey	50	18,200
8012396208	EPL TBL 2,5-4 2P	Nihayet Plakası / End Plate	2,5 - 4	Gri / Grey	20	35,750
8012396158	EPL TBL 2,5 2P+E	Nihayet Plakası / End Plate	2,5	Gri / Grey	20	40,500
8012396218	EPL1 TBL 4 2P	Nihayet Plakası / End Plate	4	Gri / Grey	20	37,830
8012396228	EPL2 TBL 4 2P	Nihayet Plakası / End Plate	4	Gri / Grey	20	37,830
8012396238	EPL3 TBL 4 2P	Nihayet Plakası / End Plate	4	Gri / Grey	20	37,830
8012396298	EPL TBL 10 2P	Nihayet Plakası / End Plate	10	Gri / Grey	10	37,050
8012396018	EPL TDS	Nihayet Plakası / End Plate	6	Gri / Grey	50	44,200
8012396028	EPL TDV	Nihayet Plakası / End Plate	6	Gri / Grey	50	44,200
8012396038	EPL TDY	Nihayet Plakası / End Plate	6	Gri / Grey	50	44,200

Renk Kodları / Color Codes

800009900....

...0	...1	...2	...3	...4	...5	...6	...9
------	------	------	------	------	------	------	------

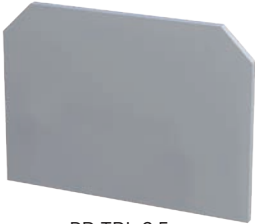

PR TBL 2,5



GPR



EPL2 TBL 4 2P

Ayırma Plakaları

Partition Plates

Ürün Kodu Product Code	Ürün Adı Product Name	Açıklama Explanation	Kesit Cross Sec. (mm ²)	Renk Color	Amb. Mik. Pack. Qty (Adet/Pcs.)	Birim Fiyatı Unit Price (TL/Adet)
8012396406	PR TBL 2,5-10	Ayırma Plakası / Partition Plate	2,5 - 10	Mavi / Blue	50	29,900
8012396408	PR TBL 2,5-10	Ayırma Plakası / Partition Plate	2,5 - 10	Gri / Grey	50	29,900
8012396508	PR TBL 4 2P	Ayırma Plakası / Partition Plate	4	Gri / Grey	20	37,050
8012396528	SPR 2,5-10	Ayırma Plakası / Partition Plate	2,5 - 10	Gri / Grey	100	16,900
8012396538	SPR 16-35	Ayırma Plakası / Partition Plate	16 - 35	Gri / Grey	50	38,350
8012396558	SPR TBL 4 2P	Ayırma Plakası / Partition Plate	4	Gri / Grey	100	21,580
8012396566	GPR	Genel Ayırma Plakası / General Partition Plate	16 -50	Mavi / Blue	20	48,750
8012396568	GPR	Genel Ayırma Plakası / General Partition Plate	16 -50	Gri / Grey	20	48,750
8012397038	PR PFT	Ayırma Plakası / Partition Plate	2,5 - 10	Gri / Grey	50	50,000

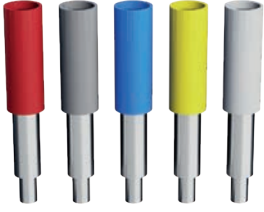

Test Fişleri

Test Sockets

Ürün Kodu Product Code	Ürün Adı Product Name	Açıklama Explanation	Renk Color	Amb. Mik. Pack. Qty (Adet/Pcs.)	Birim Fiyatı Unit Price (TL/Adet)
8014393106	TST-I 1	● Test Fişi / Test Plug	Mavi / Blue	50	47,970
8014393104	TST-I 1	● Test Fişi / Test Plug	Sarı / Yellow	50	47,970
8014393108	TST-I 1	● Test Fişi / Test Plug	Gri / Grey	50	47,970
8014393102	TST-I 1	● Test Fişi / Test Plug	Kırmızı / Red	50	47,970
8014393100	TST-I 1	● Test Fişi / Test Plug	Siyah / Black	50	47,970
8014393227	TST 1	Test Fişi / Test Plug		50	42,120
8014393237	TST 2	Test Fişi / Test Plug		50	42,120
8014393247	TST 3	Test Fişi / Test Plug		50	42,120
8014393257	TST 4	Test Fişi / Test Plug		50	42,120

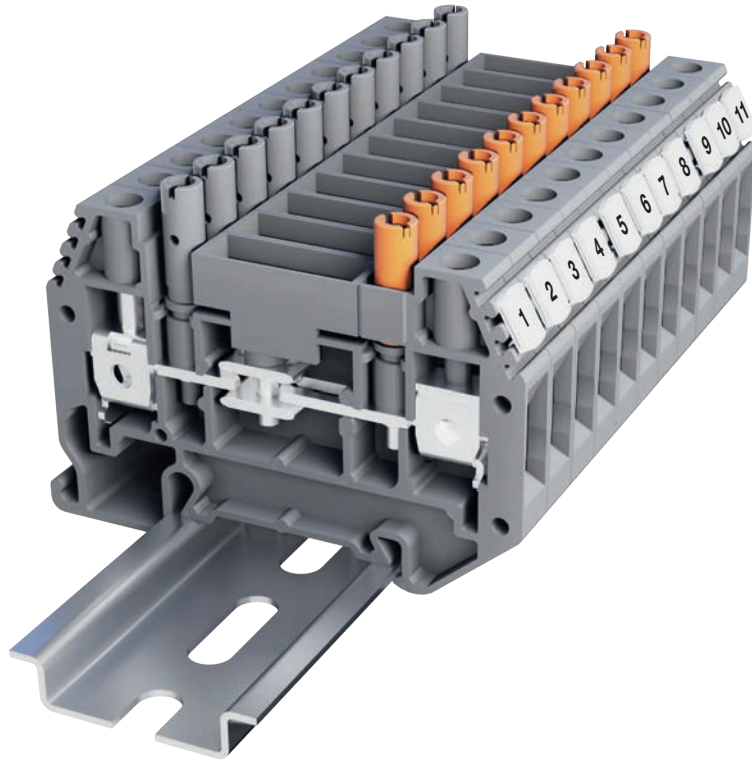

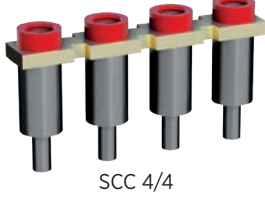

Üst Köprüler

Cross Connections

Ürün Kodu Product Code	Ürün Adı Product Name	Açıklama Explanation	Pin Pole	Kesit Cross Sec. (mm ²)	Amb. Mik. Pack. Qty (Adet/Pcs.)	Birim Fiyatı Unit Price (TL/Adet)
8013095023	SCC 2,5/2	TBL Serisi Vidalı Üst Köprü / TBL Series Screw Cross Connection	2	2,5	50	39,620
8013095033	SCC 2,5/3	TBL Serisi Vidalı Üst Köprü / TBL Series Screw Cross Connection	3	2,5	50	61,320
8013095003	SCC 2,5/10	TBL Serisi Vidalı Üst Köprü / TBL Series Screw Cross Connection	10	2,5	10	180,600
8013095123	SCC 4/2	TBL Serisi Vidalı Üst Köprü / TBL Series Screw Cross Connection	2	4	50	48,720
8013095133	SCC 4/3	TBL Serisi Vidalı Üst Köprü / TBL Series Screw Cross Connection	3	4	50	75,600
8013095103	SCC 4/10	TBL Serisi Vidalı Üst Köprü / TBL Series Screw Cross Connection	10	4	10	198,800
8013095223	SCC 6/2	TBL Serisi Vidalı Üst Köprü / TBL Series Screw Cross Connection	2	6	50	50,400
8013095233	SCC 6/3	TBL Serisi Vidalı Üst Köprü / TBL Series Screw Cross Connection	3	6	50	65,100
8013095203	SCC 6/10	TBL Serisi Vidalı Üst Köprü / TBL Series Screw Cross Connection	10	6	10	194,600
8013095323	SCC 10/2	TBL Serisi Vidalı Üst Köprü / TBL Series Screw Cross Connection	2	6	50	59,640
8013095333	SCC 10/3	TBL Serisi Vidalı Üst Köprü / TBL Series Screw Cross Connection	3	10	50	77,700
8013095303	SCC 10/10	TBL Serisi Vidalı Üst Köprü / TBL Series Screw Cross Connection	10	10	10	226,800
8013095423	SCC 16/2	TBL Serisi Vidalı Üst Köprü / TBL Series Screw Cross Connection	2	10	20	78,120
8013095433	SCC 16/3	TBL Serisi Vidalı Üst Köprü / TBL Series Screw Cross Connection	3	16	20	100,800
8013095403	SCC 16/10	TBL Serisi Vidalı Üst Köprü / TBL Series Screw Cross Connection	10	16	10	331,800
8013095523	SCC 25/2	TBL Serisi Vidalı Üst Köprü / TBL Series Screw Cross Connection	2	16	20	75,600
8013095533	SCC 25/3	TBL Serisi Vidalı Üst Köprü / TBL Series Screw Cross Connection	3	25	20	105,000
8013095503	SCC 25/10	TBL Serisi Vidalı Üst Köprü / TBL Series Screw Cross Connection	10	25	10	317,800
8013095623	SCC 35/2	TBL Serisi Vidalı Üst Köprü / TBL Series Screw Cross Connection	2	25	20	99,680
8013095633	SCC 35/3	TBL Serisi Vidalı Üst Köprü / TBL Series Screw Cross Connection	3	35	20	136,080
8013095603	SCC 35/10	TBL Serisi Vidalı Üst Köprü / TBL Series Screw Cross Connection	10	35	10	399,000
8013095723	SCC 50/2	TBL Serisi Vidalı Üst Köprü / TBL Series Screw Cross Connection	2	50	10	216,300
8013095733	SCC 50/3	TBL Serisi Vidalı Üst Köprü / TBL Series Screw Cross Connection	3	50	10	302,400
8013095823	SCC 70/2	TBL Serisi Vidalı Üst Köprü / TBL Series Screw Cross Connection	2	70	10	430,500
8013095833	SCC 70/3	TBL Serisi Vidalı Üst Köprü / TBL Series Screw Cross Connection	3	70	10	556,500
8013095923	SCC 95/2	TBL Serisi Vidalı Üst Köprü / TBL Series Screw Cross Connection	2	95	10	388,500
8013095933	SCC 95/3	TBL Serisi Vidalı Üst Köprü / TBL Series Screw Cross Connection	3	95	10	483,000
8013094023	SCC 150/2	TBL Serisi Vidalı Üst Köprü / TBL Series Screw Cross Connection	2	150	10	596,400
8013094123	SCC 4/2 TBL 4 2P	TBL Serisi Vidalı Üst Köprü / TBL Series Screw Cross Connection	2	4	50	50,400
8013094133	SCC 4/3 TBL 4 2P	TBL Serisi Vidalı Üst Köprü / TBL Series Screw Cross Connection	3	4	50	72,380
8013094163	SCC 4/6 TBL 4 2P	TBL Serisi Vidalı Üst Köprü / TBL Series Screw Cross Connection	6	4	20	78,120
8013094103	SCC 4/10 TBL 4 2P	TBL Serisi Vidalı Üst Köprü / TBL Series Screw Cross Connection	10	4	10	191,100



Tarak Köprüler

Comb Connector

Ürün Kodu Product Code	Ürün Adı Product Name	Açıklama Explanation	Pin Pole	Kesit Cross Sec. (mm ²)	Renk Color	Amb. Mik. Pack. Qty (Adet/Pcs.)	Birim Fiyatı Unit Price (TL/Adet)
8013094323	TCC 4/2	Tarak Köprü Köprü / Comb Connector	2	4	Gri / Gray	50	25,620
8013094333	TCC 4/3	Tarak Köprü Köprü / Comb Connector	3	4	Gri / Gray	50	36,120
8013094303	TCC 4/10	Tarak Köprü Köprü / Comb Connector	10	4	Gri / Gray	10	123,200
8013094403	TCC 4/10 TBL 4 2P	Tarak Köprü Köprü / Comb Connector	10	4	Gri / Gray	10	123,200
8013394823	TCC 6/2	Tarak Köprü Köprü / Comb Connector	2	6	Gri / Gray	50	61,800
8013394833	TCC 6/3	Tarak Köprü Köprü / Comb Connector	3	6	Gri / Gray	50	85,680
8013394803	TCC 6/10	Tarak Köprü Köprü / Comb Connector	10	6	Gri / Gray	10	304,500

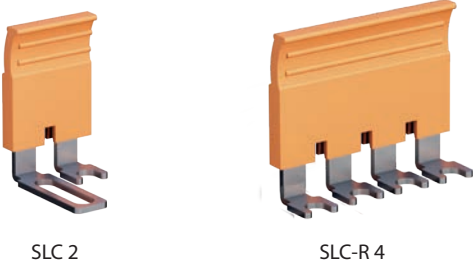

Kayar Köprüler

Sliding Connector

Ürün Kodu Product Code	Ürün Adı Product Name	Açıklama Explanation	Pin Pole	Kesit Cross Sec. (mm ²)	Amb. Mik. Pack. Qty (Adet/Pcs.)	Birim Fiyatı Unit Price (TL/Adet)
8013394923	SLC 2	TD Serisi Klemensler için Üst Köprü Cross Connection for TD Series	2	6	50	27,300
8013394933	SLC 3	TD Serisi Klemensler için Üst Köprü Cross Connection for TD Series	3	6	50	36,790
8013394943	SLC 4	TD Serisi Klemensler için Üst Köprü Cross Connection for TD Series	4	6	50	52,130
8014393307	SLC-R 2	Test Fişi / Test Plug	2	6	50	78,910
8014393317	SLC-R 3	Test Fişi / Test Plug	3	6	50	105,300
8014393327	SLC-R 4	Test Fişi / Test Plug	4	6	50	155,220

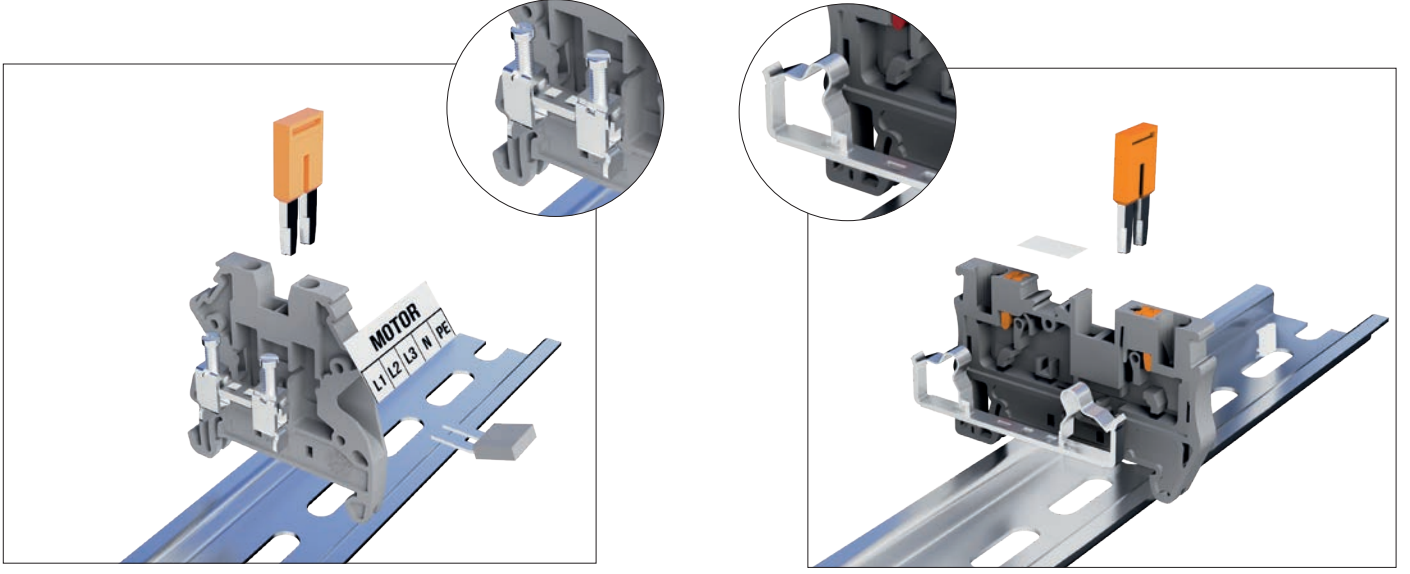

Vida Bağlantısı

Vidalı bağlantı bilinen en klasik bağlantı yöntemidir. Isıl işlem ile güçlendirilmiş sac ayaklar sayesinde uzun dönemde güvenli ve dayanıklı saha kullanımı mümkündür.

Güvenilir Bağlantı Ünitesi

Vidalı klemenslerde yer alan bağlantı ünitesi de (klemens ayağı), vidalarda olduğu gibi güçlendirilmiş çelikten üretilmektedir. Vida sıkıldığında bağlantı ünitesinde meydana gelen kuvvet bir kilitleme mekanizması oluşturur. Bu sistem sayesinde, uzun ömürlü ve güvenli bağlantı elde edilmektedir.

Push-in Bağlantı

Tbloc push-in klemensler, herhangi bir alet kullanmaksızın kolay ve hızlı montaj avantajı sağlamaktadır. Bu bağlantı teknolojisi sayesinde; tek damarlı kablolar ön hazırlığa gerek duymaksızın, çok damarlı kablolar da yüküklü olarak kolayca montajlanabilir. Ayrıca klemens üzerinde yer alan kırmızı butonlar, kullanıcıya klemensin iletken kısımlarına temas etmeden demontaj avantajı sağlamaktadır. Push-in bağlantılı klemensler titreşime karşı dayanıklıdır.

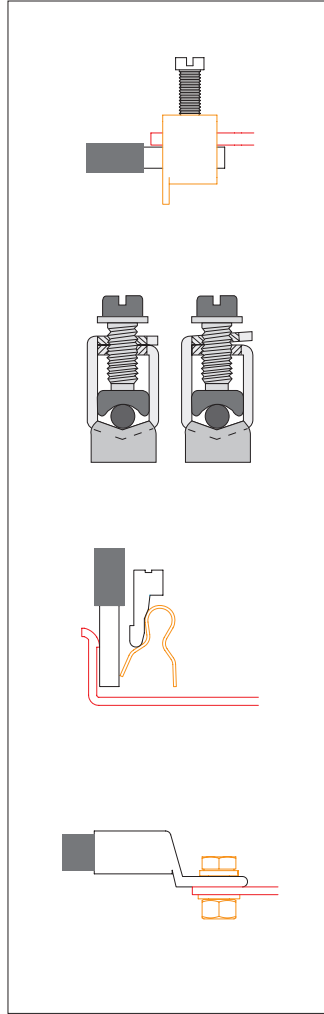

Screw Connection

Screw type connection is the classical method for terminal blocks. Reinforced clamps ensures the safe and durable connection for long time of usage.

Reliable Clamping

The connection unit (yokes) in the terminal block is made of reinforced steel, as in the screw. When the screw is tightened, the force that occurs in the connection unit creates a locking mechanism. Thanks to that, durable and safe connection is obtained.

Push-in Connection

Tbloc push-in terminal blocks provide fast assembly of cables without using a tool. With this technology, solid conductors(just stripping is enough) and flexible conductors(with end ferrules) can be assembled easily. Red buttons on top of the terminal blocks provide easy disassembly without touching conductive parts of the terminal blocks. Push-in connection is resistant to vibration hence can be used safely in many areas.

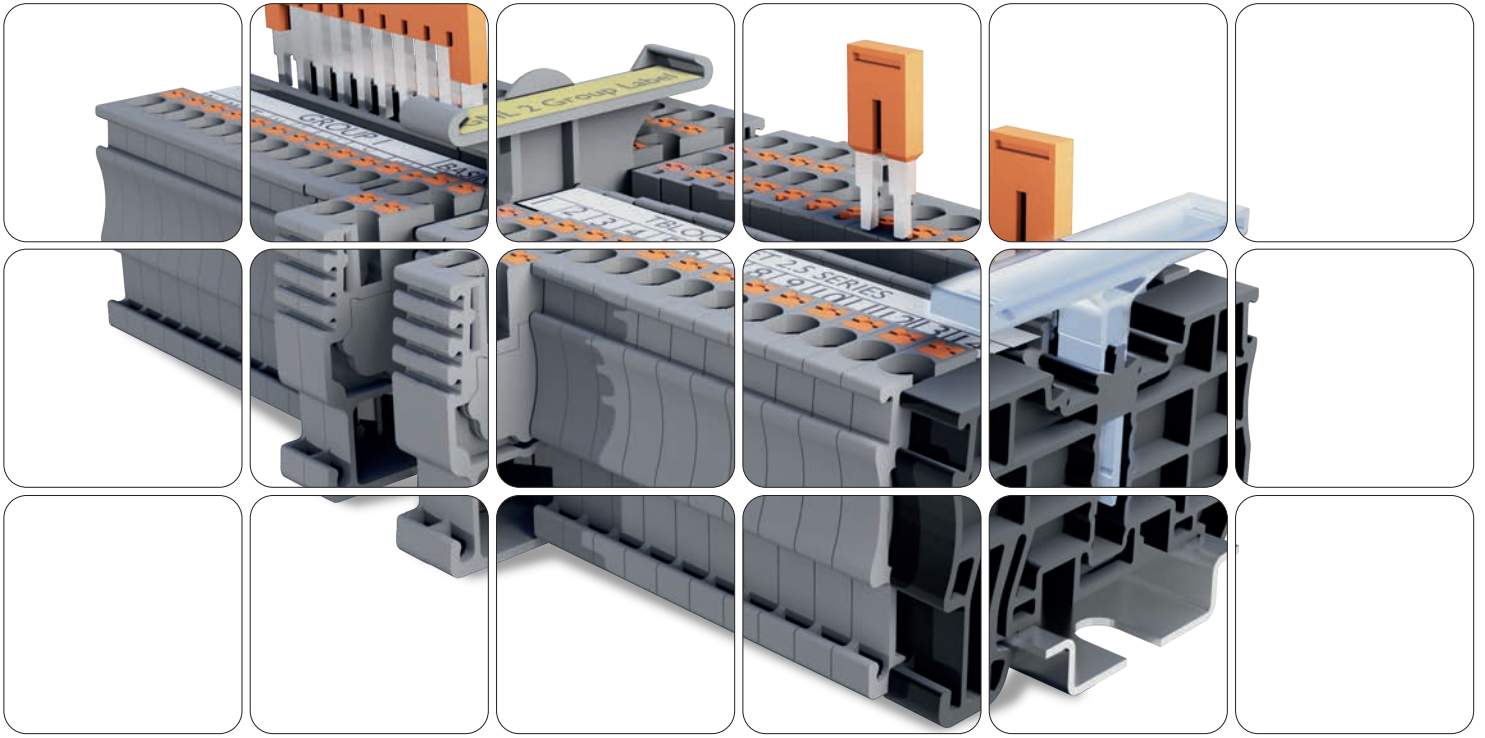

push-in klemmsler
push-in terminal blocks

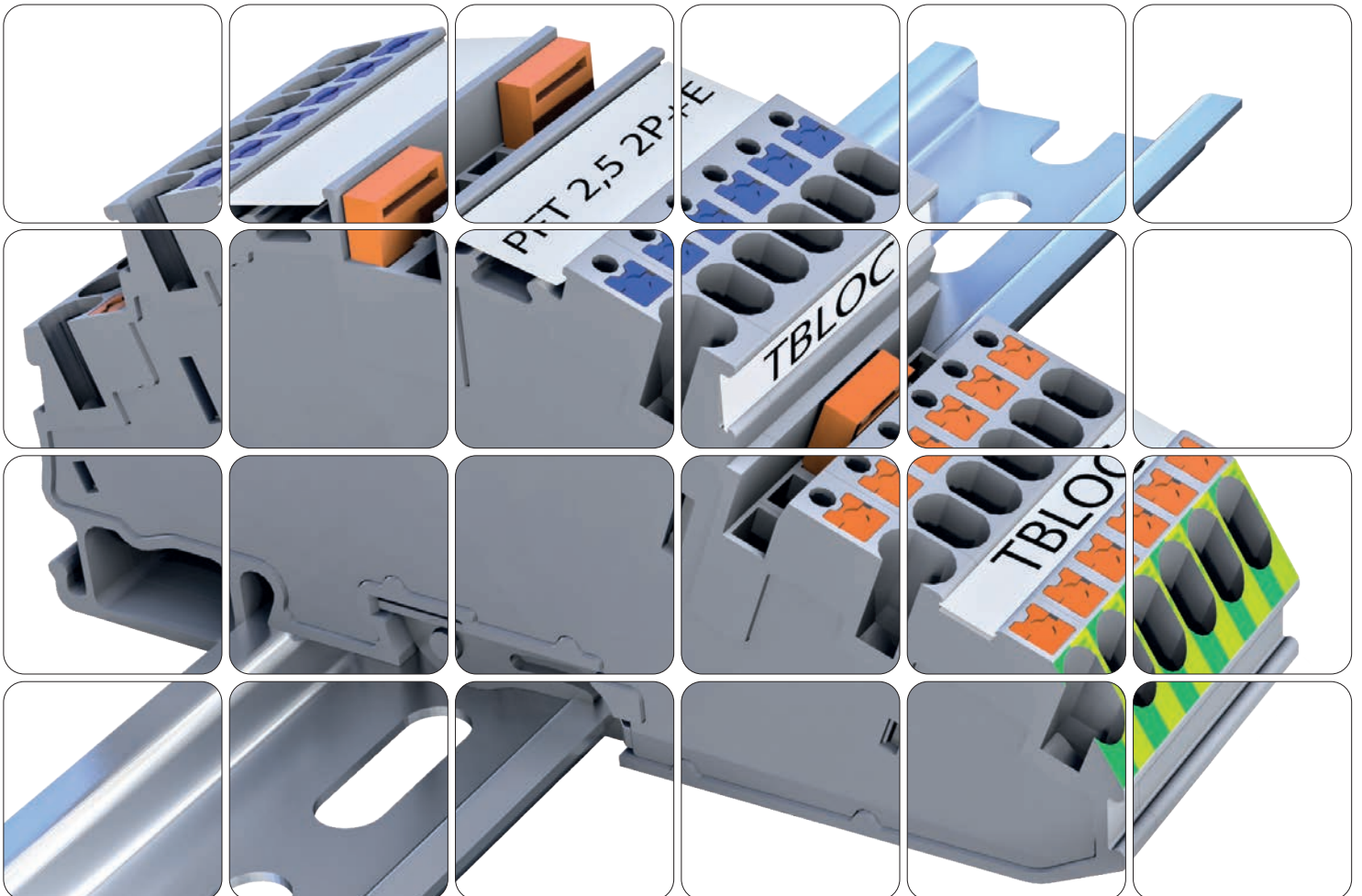

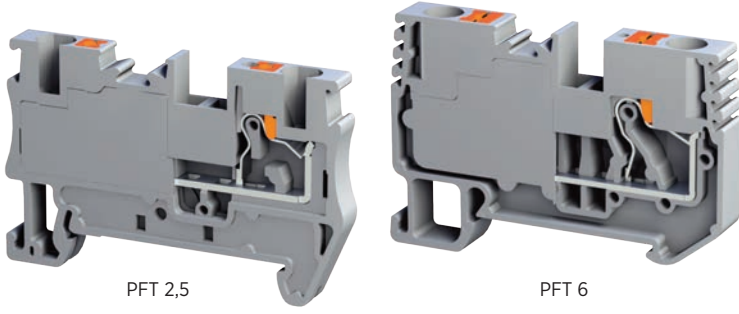

PFT 2,5

PFT 6



PFT Serisi Push-in Geçiş Klemensleri

PFT Series Push-in Feed Through Terminal Blocks

Ürün Kodu Product Code	Ürün Adı Product Name	Açıklama Explanation	Kesit Cross Sec. (mm ²)	Renk Color	Amb. Mik. Pack. Qty (Adet/Pcs.)	Koli Mik. Box.Qty. (Adet/Pcs.)	Birim Fiyatı Unit Price (TL/Adet)
8000298008	PFT 2,5	Geçiş Klemensi / Feed Through Terminal	2,5	Gri / Grey	100	1.000	27,950
8000298018	PFT 4	Geçiş Klemensi / Feed Through Terminal	4	Gri / Grey	100	800	38,350
8000298028	PFT 6	Geçiş Klemensi / Feed Through Terminal	6	Gri / Grey	50	500	59,800
8000298038	PFT 10	Geçiş Klemensi / Feed Through Terminal	10	Gri / Grey	30	600	96,200
8000298043*	PFT 16*	Geçiş Klemensi / Feed Through Terminal	16	Gri / Grey	25	500	182,000

*PFT 16 Sadece gri olarak temin edilmektedir.

Renk Kodları / Color Codes
800009900....	...0	...1	...2	...3	...4	...5	...6	...9

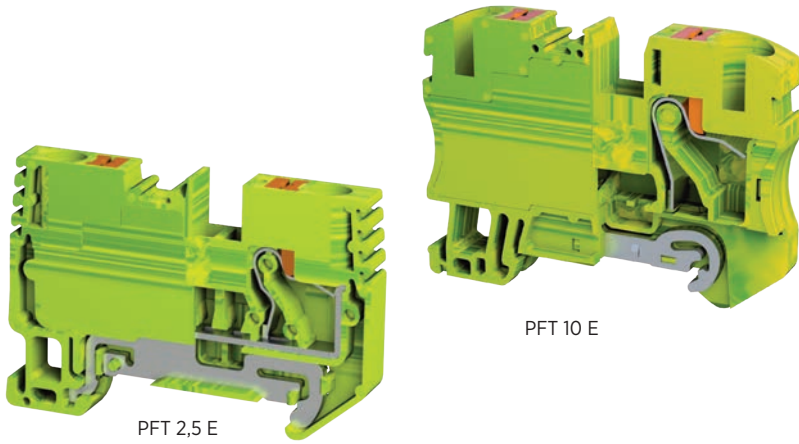

PFT 2,5 E

PFT 10 E



PFT Serisi Push-in Topraklama Klemensleri

PFT Series Push-in Earth Terminal Blocks

Ürün Kodu Product Code	Ürün Adı Product Name	Açıklama Explanation	Kesit Cross Sec. (mm ²)	Renk Color	Amb. Mik. Pack. Qty (Adet/Pcs.)	Koli Mik. Box.Qty. (Adet/Pcs.)	Birim Fiyatı Unit Price (TL/Adet)
8001298064	PFT 2,5 E	Topraklama Klemensi / Earth Terminal	2,5	Sarı-Yeşil / Yellow-Green	50	500	113,100
8001298074	PFT 4 E	Topraklama Klemensi / Earth Terminal	4	Sarı-Yeşil / Yellow-Green	50	500	143,000
8001298084	PFT 6 E	Topraklama Klemensi / Earth Terminal	6	Sarı-Yeşil / Yellow-Green	25	500	192,400
8001298104	PFT 10 E	Topraklama Klemensi / Earth Terminal	10	Sarı-Yeşil / Yellow-Green	30	600	254,800
8001298114	PFT 16 E	Topraklama Klemensi / Earth Terminal	16	Sarı-Yeşil / Yellow-Green	25	600	338,000

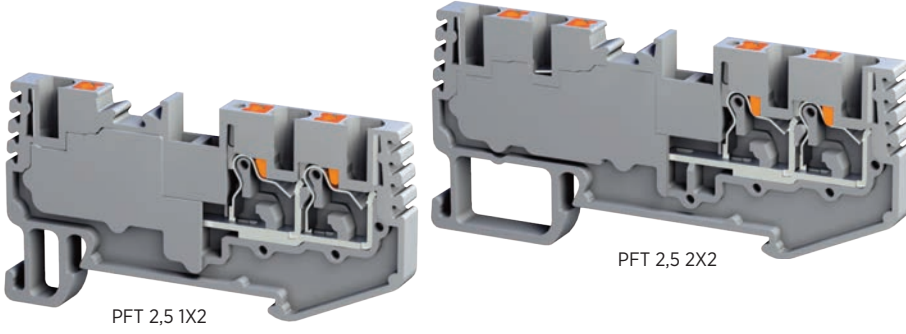

PFT 2,5 1X2

PFT 2,5 2X2

PFT Serisi Push-in Çok Girişli ve Çıkışlı Klemensler

PFT Series Push-in Multilevel Terminal Blocks

Ürün Kodu Product Code	Ürün Adı Product Name	Açıklama Explanation	Kesit Cross Sec. (mm ²)	Renk Color	Amb. Mik. Pack. Qty (Adet/Pcs.)	Koli Mik. Box.Qty. (Adet/Pcs.)	Birim Fiyatı Unit Price (TL/Adet)
8000298068	PFT 2,5 1X2	1 Giriş 2 Çıkış Geçiş Klemensi 1 Input 2 Output Feed Through Terminal	2,5	Gri / Grey	40	400	64,350
8000298060	PFT 2,5 1X2	1 Giriş 2 Çıkış Geçiş Klemensi 1 Input 2 Output Feed Through Terminal	2,5	Siyah / Black	40	400	64,350
8000298066	PFT 2,5 1X2	1 Giriş 2 Çıkış Geçiş Klemensi 1 Input 2 Output Feed Through Terminal	2,5	Mavi/Blue	40	400	64,350
8000298078	PFT 2,5 2X2	2 Giriş 2 Çıkış Geçiş Klemensi 2 Input 2 Output Feed Through Terminal	2,5	Gri / Grey	40	400	81,900

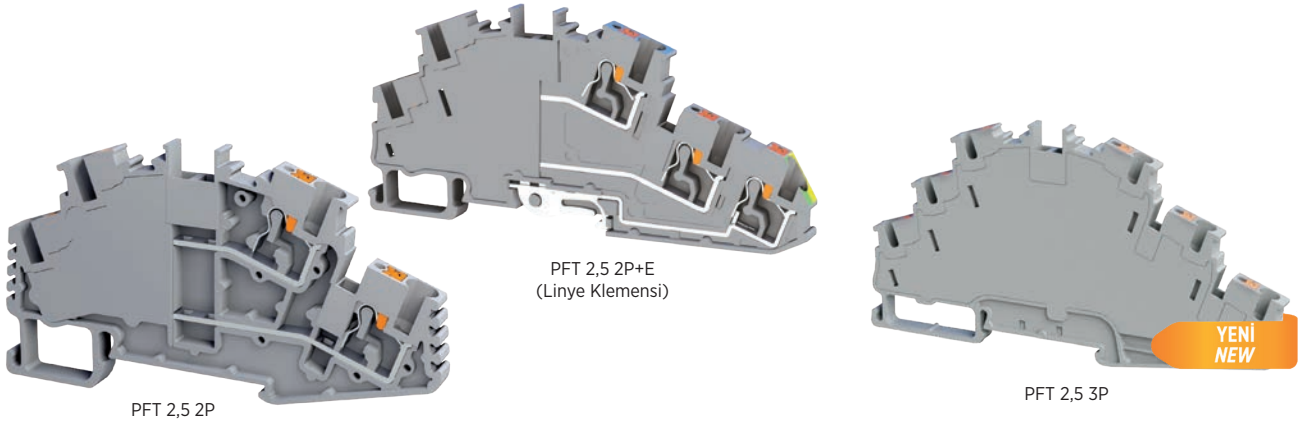

PFT 2,5 2P

PFT 2,5 2P+E
(Linye Klemensi)

PFT 2,5 3P

PFT Serisi Push-in Çok Katlı Klemensler

PFT Series Push-in Multilevel Terminal Blocks

Ürün Kodu Product Code	Ürün Adı Product Name	Açıklama Explanation	Kesit Cross Sec. (mm ²)	Renk Color	Amb. Mik. Pack. Qty (Adet/Pcs.)	Koli Mik. Box.Qty. (Adet/Pcs.)	Birim Fiyatı Unit Price (TL/Adet)
8002298098	PFT 2,5 2P	Çok Katlı Klemens / Multilevel Terminal	2,5	Gri / Grey	50	500	72,800
8002298096	PFT 2,5 2P	Çok Katlı Klemens / Multilevel Terminal	2,5	Mavi/Blue	50	500	72,800
8002298198	PFT 2,5 3P	Çok Katlı Klemens / Multilevel Terminal	2,5	Gri / Grey	30	600	195,000
8002298118	PFT 4 2P	Çok Katlı Klemens / Multilevel Terminal	4	Gri / Grey	50	500	109,200
8002298108	PFT 2,5 2P+E	Çok Katlı Klemens + Topraklama Multilevel Terminal + Earth	2,5	Gri / Grey	30	600	221,000



PCC 2,5/2

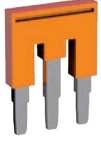

PCC 2,5/3



PCC 4/10

Üst Köprüler

Push-in Cross Connections

Ürün Kodu Product Code	Ürün Adı Product Name	Pin Pole	Açıklama Explanation	Kesit Cross Sec. (mm ²)	Renk Color	Amb. Mik. Pack. Qty (Adet/Pcs.)	Birim Fiyatı Unit Price (TL/Adet)
8013294523	PCC 2,5/2	2	PFT ve NTB Serisi Üst Köprü PFT and NTB Series Cross Connections	2,5	Turuncu / Orange	100	23,400
8013294533	PCC 2,5/3	3	PFT ve NTB Serisi Üst Köprü PFT and NTB Series Cross Connections	2,5	Turuncu / Orange	100	35,100
8013294503	PCC 2,5/10	10	PFT ve NTB Serisi Üst Köprü PFT and NTB Series Cross Connections	2,5	Turuncu / Orange	10	117,000
8013294623	PCC 4/2	2	PFT ve NTB Serisi Üst Köprü PFT and NTB Series Cross Connections	4	Turuncu / Orange	100	27,950
8013294633	PCC 4/3	3	PFT ve NTB Serisi Üst Köprü PFT and NTB Series Cross Connections	4	Turuncu / Orange	100	41,600
8013294603	PCC 4/10	10	PFT ve NTB Serisi Üst Köprü PFT and NTB Series Cross Connections	4	Turuncu / Orange	10	136,500
8013294723	PCC 6/2	2	PFT ve NTB Serisi Üst Köprü PFT and NTB Series Cross Connections	6	Turuncu / Orange	50	32,760
8013294733	PCC 6/3	3	PFT ve NTB Serisi Üst Köprü PFT and NTB Series Cross Connections	6	Turuncu / Orange	50	49,140
8013294703	PCC 6/10	10	PFT ve NTB Serisi Üst Köprü PFT and NTB Series Cross Connections	6	Turuncu / Orange	10	163,800
8013295703	PCC 6/10-T	10	NTB Serisi Üst Köprü NTB Series Cross Connections	6	Turuncu / Orange	10	175,000
8013294823	PCC 10/2	2	PFT ve NTB Serisi Üst Köprü PFT and NTB Series Cross Connections	10	Turuncu / Orange	10	65,000
8013294833	PCC 10/3	3	PFT ve NTB Serisi Üst Köprü PFT and NTB Series Cross Connections	10	Turuncu / Orange	10	97,500
8013294923	PCC 16/2	2	PFT Serisi Üst Köprü PFT Series Cross Connections	16	Turuncu / Orange	10	84,500

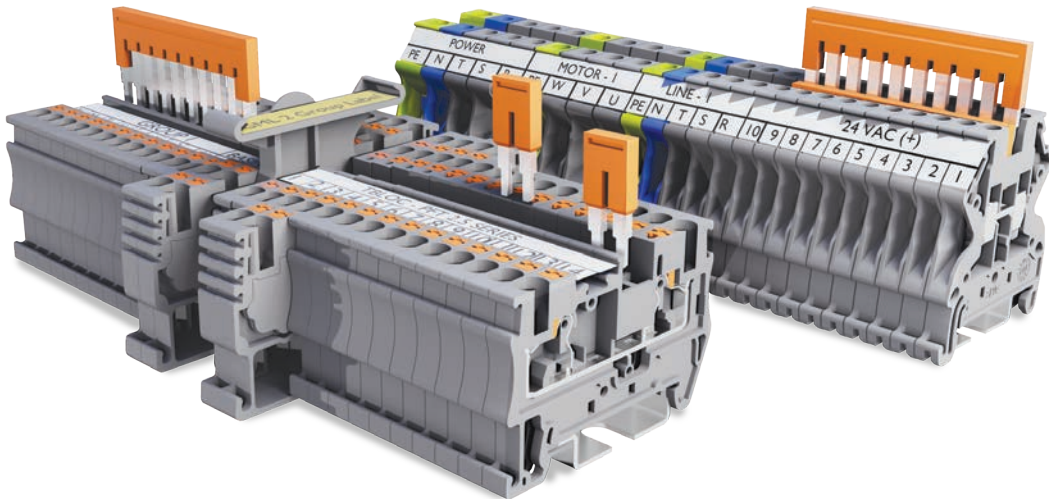



SRK 16/3



SRK 16/8

Sıra Klemensler

Terminal Strips

Ürün Kodu Product Code	Ürün Adı Product Name	Açıklama Explanation	Kutup Sayısı Number of Poles	Renk Color	Amb. Mik. Pack. Qty (Adet/Pcs.)	Birim Fiyatı Unit Price (TL/Adet)
8006097008	SRK 16/2	Sıra Klemens / Terminal Strips	2	Gri / Grey	96	64,350
8006097018	SRK 16/3	Sıra Klemens / Terminal Strips	3	Gri / Grey	32	102,700
8006097028	SRK 16/4	Sıra Klemens / Terminal Strips	4	Gri / Grey	48	124,800
8006097038	SRK 16/5	Sıra Klemens / Terminal Strips	5	Gri / Grey	32	156,000
8006097048	SRK 16/6	Sıra Klemens / Terminal Strips	6	Gri / Grey	30	180,700
8006097058	SRK 16/8	Sıra Klemens / Terminal Strips	8	Gri / Grey	24	240,500
8006097068	SRK 16/10	Sıra Klemens / Terminal Strips	10	Gri / Grey	16	292,500
8006097078	SRK 16/12	Sıra Klemens / Terminal Strips	12	Gri / Grey	8	373,750

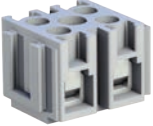

CSK 2,5

Cihaz Sıra Klemensler

Modular Terminal Strips

Ürün Kodu Product Code	Ürün Adı Product Name	Açıklama Explanation	Kesit Cross Sec. (mm ²)	Renk Color	Amb. Mik. Pack. Qty (Adet/Pcs.)	Birim Fiyatı Unit Price (TL/Adet)
8006097108	CSK 2,5	Cihaz Sıra Klemens / Modular Terminal Strips	2,5	Gri / Grey	100	31,850
8006097118	CSK 6	Cihaz Sıra Klemens / Modular Terminal Strips	6	Gri / Grey	60	52,650

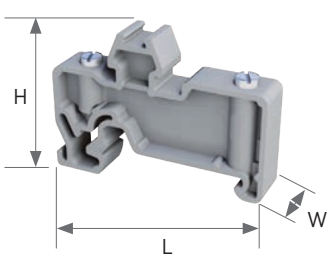

SS 1

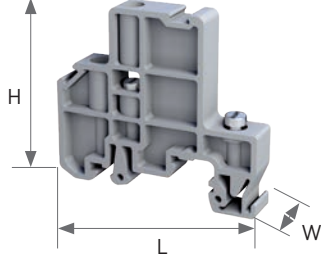

SS 2

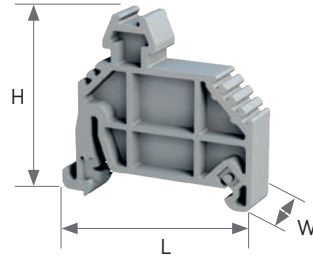

PS 1

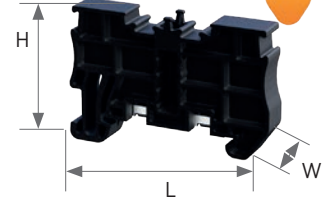

PS 2

Durdurucu

End Bracket

Ürün Kodu Product Code	Ürün Adı Product Name	Açıklama Explanation	Ebatlar Dimension (W/H/L)(mm)	Renk Color	Amb. Mik. Pack. Qty (Adet/Pcs.)	Birim Fiyatı Unit Price (TL/Adet)
8010097308	SS 1	Durdurucu (Vidalı) / End Bracket (Screw)	8/30,7/26,8	Gri / Grey	50	25,350
8010097318	SS 2	Durdurucu (Vidalı) / End Bracket (Screw)	10/50/50,5	Gri / Grey	50	26,000
8010197328	PS 1	Durdurucu (Yaylı) / End Bracket (Spring)	10/42,8/45,6	Gri / Grey	50	25,350
8010197428	PS 2	Durdurucu (Yaylı) / End Bracket (Spring)	8/35/53,6	Gri / Grey	50	25,350
8010197420	PS 2	Durdurucu (Yaylı) / End Bracket (Spring)	8/35/53,6	Siyah/ Black	50	25,350

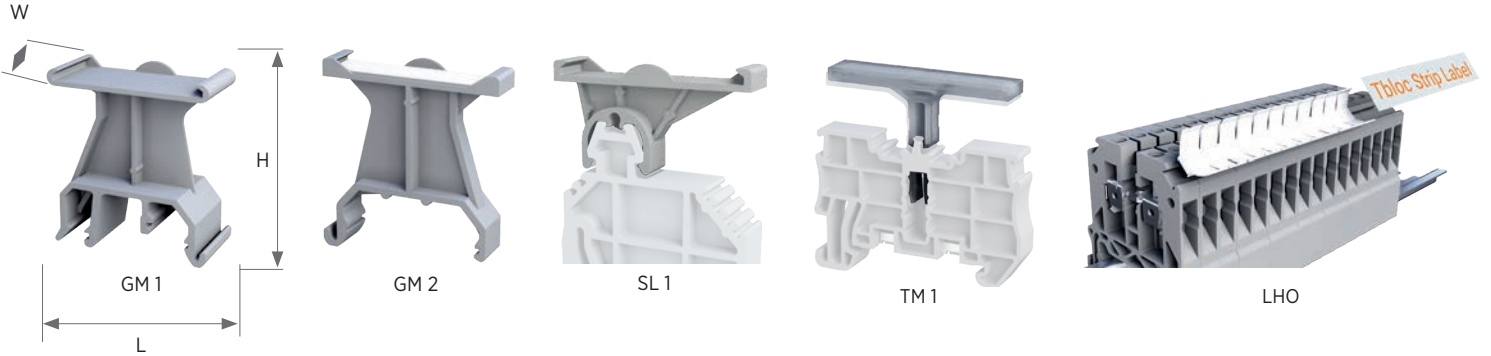

Grup Etiketli

Group Marker

Ürün Kodu Product Code	Ürün Adı Product Name	Açıklama Explanation	Ebatlar Dimension (W/H/L)(mm)	Renk Color	Amb. Mik. Pack. Qty (Adet/Pcs.)	Birim Fiyatı Unit Price (TL/Adet)
8014393008	GM 1	Grup Etiketli / Group Marker	19,5/47/43,7	Gri / Grey	50	35,750
8014393018	GM 2	Grup Etiketli / Group Marker	9,5/47/44,4	Gri / Grey	50	34,710
8012396008	SL 1	Grup Etiketli / Group Marker	9,5/43,7/22,6	Gri / Grey	50	37,830
8020390009	LHO	Şerit Etiket Tutucu / Strip Label Holder	---	Beyaz / White	10	8,840
8014393020	TM 1	PS 2 Şeffaf Etiket Kılıfı / PS 2 Transpared Label Holder	8/45/29,2	Şeffaf Transtered	50	24,100

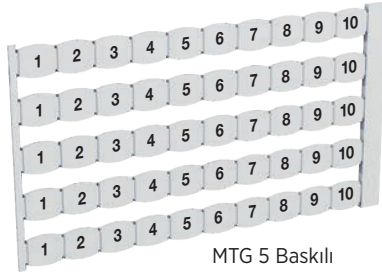

MTG 5 Baskılı

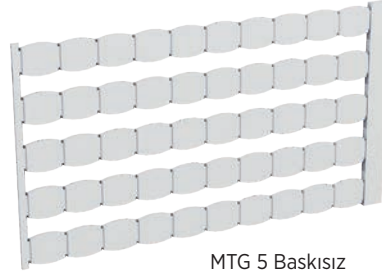

MTG 5 Baskısız

Ürün Kodu Product Code	Ürün Adı Product Name	Açıklama Description	Plaka Miktarı Plate Qty (Adet/Pcs.)	Amb. Mik. Pack. Qty (Plaka-Plates/Pcs.)	Plaka Fiyatı Plate Price (TL)	Adet Fiyatı Pcs. Price (TL/Adet)
8020389019	MTG 5 Baskılı	Baskılı / Printed	50	500	79,04	1,2350
8020389009	MTG 5 Baskısız	Boş / Empty	50	500	61,75	1,5808
8020389029	MTG 5 (1-10)	1-10	50	500	79,04	1,5808
8020389039	MTG 5 (11-20)	11-20	50	500	79,04	1,5808
8020389049	MTG 5 (21-30)	21-30	50	500	79,04	1,5808
8020389059	MTG 5 (31-40)	31-40	50	500	79,04	1,5808
8020389069	MTG 5 (41-50)	41-50	50	500	79,04	1,5808
8020389079	MTG 5 (51-60)	51-60	50	500	79,04	1,5808
8020389089	MTG 5 (61-70)	61-70	50	500	79,04	1,5808
8020389099	MTG 5 (71-80)	71-80	50	500	79,04	1,5808
8020389109	MTG 5 (81-90)	81-90	50	500	79,04	1,5808
8020389119	MTG 5 (91-100)	91-100	50	500	79,04	1,5808
8020389129	MTG 5 (1-50)	1-50	50	500	79,04	1,5808
8020389139	MTG 5 (51-100)	51-100	50	500	79,04	1,5808
8020389149	MTG 5 (101-150)	101-150	50	500	79,04	1,5808
8020389159	MTG 5 (151-200)	151-200	50	500	79,04	1,5808
8020389169	MTG 5 (201-250)	201-250	50	500	79,04	1,5808
8020389179	MTG 5 (251-300)	251-300	50	500	79,04	1,5808
8020389189	MTG 5 (301-350)	301-350	50	500	79,04	1,5808
8020389199	MTG 5 (351-400)	351-400	50	500	79,04	1,5808
8020389209	MTG 5 (401-450)	401-450	50	500	79,04	1,5808
8020389219	MTG 5 (451-500)	451-500	50	500	79,04	1,5808
8020388019	MTG 6 Baskılı	Baskılı / Printed	50	500	86,06	1,7212
8020388009	MTG 6 Baskısız	Boş / Empty	50	500	69,81	1,3962
8020388839	MTG 6 (L1, L2, L3, N)	L1, L2, L3, N	50	500	86,06	1,7212
8020388309	MTG 6 (0)	0	50	500	86,06	1,7212
8020388319	MTG 6 (1)	1	50	500	86,06	1,7212
8020388599	MTG 6 (5)	5	50	500	86,06	1,7212
8020388329	MTG 6 (2)	2	50	500	86,06	1,7212
8020388339	MTG 6 (3)	3	50	500	86,06	1,7212
8020388349	MTG 6 (4)	4	50	500	86,06	1,7212
8020388359	MTG 6 (5)	5	50	500	86,06	1,7212
8020388369	MTG 6 (6)	6	50	500	86,06	1,7212
8020388379	MTG 6 (7)	7	50	500	86,06	1,7212
8020388389	MTG 6 (8)	8	50	500	86,06	1,7212
8020388399	MTG 6 (9)	9	50	500	86,06	1,7212
8020388409	MTG 6 (10)	10	50	500	86,06	1,7212
8020388029	MTG 6 (0-9)	0-9	50	500	86,06	1,7212
8020388039	MTG 6 (1-10)	1-10	50	500	86,06	1,7212
8020388879	MTG 6 (11-20)	11-20	50	500	86,06	1,7212
8020388889	MTG 6 (21-30)	21-30	50	500	86,06	1,7212
8020388899	MTG 6 (31-40)	31-40	50	500	86,06	1,7212
8020388909	MTG 6 (41-50)	41-50	50	500	86,06	1,7212
8020388919	MTG 6 (51-60)	51-60	50	500	86,06	1,7212
8020388929	MTG 6 (61-70)	61-70	50	500	86,06	1,7212
8020388939	MTG 6 (71-80)	71-80	50	500	86,06	1,7212
8020388949	MTG 6 (81-90)	81-90	50	500	86,06	1,7212
8020388959	MTG 6 (91-100)	91-100	50	500	86,06	1,7212

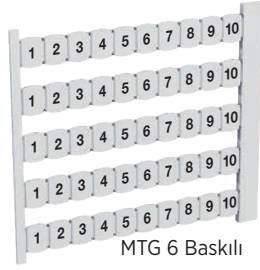

MTG 6 Baskılı

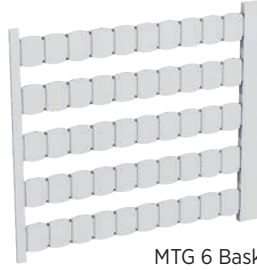

MTG 6 Baskısız

Ürün Kodu Product Code	Ürün Adı Product Name	Açıklama Description	Plaka Miktarı Plate Qty (Adet/Pcs.)	Amb. Mik. Pack. Qty (Plaka-Plates/Pcs.)	Plaka Fiyatı Plate Price (TL)	Adet Fiyatı Pcs. Price (TL/Adet)
8020388049	MTG 6 (1-50)	1-50	50	500	86,06	1,7212
8020388059	MTG 6 (51-100)	51-100	50	500	86,06	1,7212
8020388069	MTG 6 (101-150)	101-150	50	500	86,06	1,7212
8020388079	MTG 6 (151-200)	151-200	50	500	86,06	1,7212
8020388089	MTG 6 (201-250)	201-250	50	500	86,06	1,7212
8020388099	MTG 6 (251-300)	251-300	50	500	86,06	1,7212
8020388109	MTG 6 (301-350)	301-350	50	500	86,06	1,7212
8020388119	MTG 6 (351-400)	351-400	50	500	86,06	1,7212
8020388129	MTG 6 (401-450)	401-450	50	500	86,06	1,7212
8020388139	MTG 6 (451-500)	451-500	50	500	86,06	1,7212
8020388149	MTG 6 (501-550)	501-550	50	500	86,06	1,7212
8020388159	MTG 6 (551-600)	551-600	50	500	86,06	1,7212
8020388169	MTG 6 (601-650)	601-650	50	500	86,06	1,7212
8020388179	MTG 6 (651-700)	651-700	50	500	86,06	1,7212
8020388189	MTG 6 (701-750)	701-750	50	500	86,06	1,7212
8020388199	MTG 6 (751-800)	751-800	50	500	86,06	1,7212
8020388209	MTG 6 (801-850)	801-850	50	500	86,06	1,7212
8020388219	MTG 6 (851-900)	851-900	50	500	86,06	1,7212
8020388229	MTG 6 (901-950)	901-950	50	500	86,06	1,7212
8020388239	MTG 6 (951-1000)	951-1000	50	500	86,06	1,7212
8020388859	MTG 6 (RSTN)	RSTN	50	500	86,06	1,7212
8020388779	MTG 6 (+)	+	50	500	86,06	1,7212
8020388789	MTG 6 (-)	-	50	500	86,06	1,7212
8020388429	MTG 6 (B)	B	50	500	86,06	1,7212
8020388849	MTG 6 (PE)	PE	50	500	86,06	1,7212
8020388459	MTG 6 (E)	E	50	500	86,06	1,7212
8020388529	MTG 6 (L)	L	50	500	86,06	1,7212
8020388549	MTG 6 (N)	N	50	500	86,06	1,7212
8020388659	MTG 6 (Y)	Y	50	500	86,06	1,7212
8020388589	MTG 6 (R)	R	50	500	86,06	1,7212
8020388829	MTG 6 (L1, L2, L3)	L1, L2, L3	50	500	86,06	1,7212
8020388799	MTG 6 (L1)	L1	50	500	86,06	1,7212
8020388809	MTG 6 (L2)	L2	50	500	86,06	1,7212
8020388499	MTG 6 (I)	I	50	500	86,06	1,7212
8020388449	MTG 6 (D)	D	50	500	86,06	1,7212
8020388519	MTG 6 (K)	K	50	500	86,06	1,7212
8020388469	MTG 6 (F)	F	50	500	86,06	1,7212
8020388419	MTG 6 (A)	A	50	500	86,06	1,7212
8020388539	MTG 6 (M)	M	50	500	86,06	1,7212
8020388569	MTG 6 (P)	P	50	500	86,06	1,7212
8020388679	MTG 6 (X1)	X1	50	500	86,06	1,7212
8020388689	MTG 6 (X2)	X2	50	500	86,06	1,7212
8020388699	MTG 6 (X3)	X3	50	500	86,06	1,7212
8020388709	MTG 6 (X4)	X4	50	500	86,06	1,7212
8020388719	MTG 6 (X5)	X5	50	500	86,06	1,7212
8020388729	MTG 6 (X6)	X6	50	500	86,06	1,7212
8020388739	MTG 6 (X7)	X7	50	500	86,06	1,7212
8020388749	MTG 6 (X8)	X8	50	500	86,06	1,7212

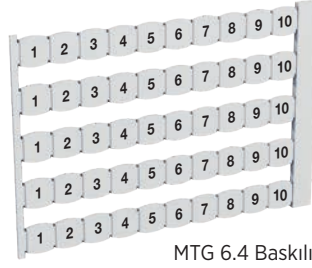

MTG 6.4 Baskılı

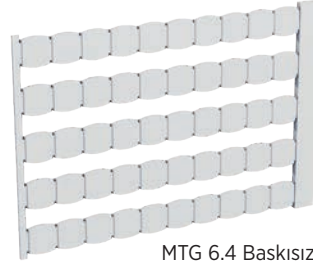

MTG 6.4 Baskısız

Ürün Kodu Product Code	Ürün Adı Product Name	Açıklama Description	Plaka Miktarı Plate Qty (Adet/Pcs.)	Amb. Mik. Pack. Qty (Plaka-Plates/Pcs.)	Plaka Fiyatı Plate Price (TL)	Adet Fiyatı Pcs. Price (TL/Adet)
8020388759	MTG 6 (X9)	X9	50	500	86,06	1,7212
8020388769	MTG 6 (X10)	X10	50	500	86,06	1,7212
8020388439	MTG 6 (C)	C	50	500	86,06	1,7212
8020388629	MTG 6 (V)	V	50	500	86,06	1,7212
8020388479	MTG 6 (G)	G	50	500	86,06	1,7212
8020388489	MTG 6 (H)	H	50	500	86,06	1,7212
8020388819	MTG 6 (L3)	L3	50	500	86,06	1,7212
8020388869	MTG 6 (MP)	MP	50	500	86,06	1,7212
8020388609	MTG 6 (T)	T	50	500	86,06	1,7212
8020387019	MTG 6,4 Baskılı	Baskılı / Printed	50	500	92,56	1,8512
8020387009	MTG 6,4 Baskısız	Boş / Empty	50	500	79,56	1,5912
8020387309	MTG 6,4 (1)	1	50	500	92,56	1,8512
8020387319	MTG 6,4 (2)	2	50	500	92,56	1,8512
8020387329	MTG 6,4 (3)	3	50	500	92,56	1,8512
8020387339	MTG 6,4 (4)	4	50	500	92,56	1,8512
8020387349	MTG 6,4 (5)	5	50	500	92,56	1,8512
8020387359	MTG 6,4 (6)	6	50	500	92,56	1,8512
8020387369	MTG 6,4 (7)	7	50	500	92,56	1,8512
8020387379	MTG 6,4 (8)	8	50	500	92,56	1,8512
8020387389	MTG 6,4 (9)	9	50	500	92,56	1,8512
8020387399	MTG 6,4 (10)	10	50	500	92,56	1,8512
8020387029	MTG 6,4 (0-9)	0-9	50	500	92,56	1,8512
8020387039	MTG 6,4 (1-50)	1-50	50	500	92,56	1,8512
8020387049	MTG 6,4 (51-100)	51-100	50	500	92,56	1,8512
8020387059	MTG 6,4 (101-150)	101-150	50	500	92,56	1,8512
8020387069	MTG 6,4 (151-200)	151-200	50	500	92,56	1,8512
8020387079	MTG 6,4 (201-250)	201-250	50	500	92,56	1,8512
8020387089	MTG 6,4 (251-300)	251-300	50	500	92,56	1,8512
8020387099	MTG 6,4 (301-350)	301-350	50	500	92,56	1,8512
8020387109	MTG 6,4 (351-400)	351-400	50	500	92,56	1,8512
8020387119	MTG 6,4 (401-450)	401-450	50	500	92,56	1,8512
8020387129	MTG 6,4 (451-500)	451-500	50	500	92,56	1,8512
8020387139	MTG 6,4 (501-550)	501-550	50	500	92,56	1,8512
8020387149	MTG 6,4 (551-600)	551-600	50	500	92,56	1,8512
8020387159	MTG 6,4 (601-650)	601-650	50	500	92,56	1,8512
8020387169	MTG 6,4 (651-700)	651-700	50	500	92,56	1,8512
8020387179	MTG 6,4 (701-750)	701-750	50	500	92,56	1,8512
8020387189	MTG 6,4 (751-800)	751-800	50	500	92,56	1,8512
8020387199	MTG 6,4 (801-850)	801-850	50	500	92,56	1,8512
8020387209	MTG 6,4 (851-900)	851-900	50	500	92,56	1,8512
8020387219	MTG 6,4 (901-950)	901-950	50	500	92,56	1,8512
8020387229	MTG 6,4 (951-1000)	951-1000	50	500	92,56	1,8512
8020387239	MTG 6,4 (1001-1050)	1001-1050	50	500	92,56	1,8512
8020387249	MTG 6,4 (1051-1100)	1051-1100	50	500	71,20	1,8512
8020386019	MTG 8 Baskılı	Baskılı / Printed	50	500	95,81	1,9162
8020386009	MTG 8 Baskısız	Boş / Empty	50	500	79,04	1,5808
8020386199	MTG 8 (0)	0	50	500	95,81	1,9162

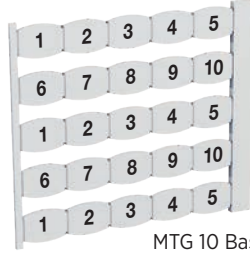

MTG 10 Baskılı

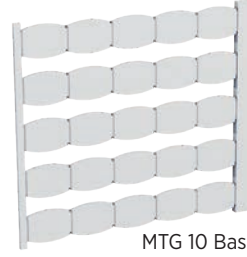

MTG 10 Baskısız

Ürün Kodu Product Code	Ürün Adı Product Name	Açıklama Description	Plaka Miktarı Plate Qty (Adet/Pcs.)	Amb. Mik. Pack. Qty (Plaka-Plates/Pcs.)	Plaka Fiyatı Plate Price (TL)	Adet Fiyatı Pcs. Price (TL/Adet)
8020386209	MTG 8 (1)	1	50	500	95,81	1,9162
8020386219	MTG 8 (2)	2	50	500	95,81	1,9162
8020386229	MTG 8 (3)	3	50	500	95,81	1,9162
8020386239	MTG 8 (4)	4	50	500	95,81	1,9162
8020386249	MTG 8 (5)	5	50	500	95,81	1,9162
8020386259	MTG 8 (6)	6	50	500	95,81	1,9162
8020386269	MTG 8 (7)	7	50	500	95,81	1,9162
8020386279	MTG 8 (8)	8	50	500	95,81	1,9162
8020386289	MTG 8 (9)	9	50	500	95,81	1,9162
8020386299	MTG 8 (10)	10	50	500	95,81	1,9162
8020386309	MTG 8 (0-9)	0-9	50	500	95,81	1,9162
8020386319	MTG 8 (1-10)	1-10	50	500	95,81	1,9162
8020386029	MTG 8 (1-50)	1-50	50	500	95,81	1,9162
8020386039	MTG 8 (51-100)	51-100	50	500	95,81	1,9162
8020386049	MTG 8 (101-150)	101-150	50	500	95,81	1,9162
8020386059	MTG 8 (151-200)	151-200	50	500	95,81	1,9162
8020386069	MTG 8 (201-250)	201-250	50	500	95,81	1,9162
8020386079	MTG 8 (251-300)	251-300	50	500	95,81	1,9162
8020386089	MTG 8 (301-350)	301-350	50	500	95,81	1,9162
8020386099	MTG 8 (351-400)	351-400	50	500	95,81	1,9162
8020386109	MTG 8 (401-450)	401-450	50	500	95,81	1,9162
8020386119	MTG 8 (451-500)	451-500	50	500	95,81	1,9162
8020386169	MTG 8 (701-750)	701-750	50	500	95,81	1,9162
8020386189	MTG 8 (801-850)	801-850	50	500	95,81	1,9162
8020386329	MTG 8 (+)	+	50	500	95,81	1,9162
8020386339	MTG 8 (-)	-	50	500	95,81	1,9162
8020386349	MTG 8 (PE)	PE	50	500	95,81	1,9162
8020386359	MTG 8 (L)	L	50	500	95,81	1,9162
8020386369	MTG 8 (N)	N	50	500	95,81	1,9162
8020386379	MTG 8 (L1, L2, L3)	L1, L2, L3	50	500	95,81	1,9162
8020386389	MTG 8 (L1)	L1	50	500	95,81	1,9162
8020386399	MTG 8 (L2)	L2	50	500	95,81	1,9162
8020386409	MTG 8 (L3)	L3	50	500	95,81	1,9162
8020385019	MTG 10 Baskılı	Baskılı / Printed	25	250	102,31	4,0924
8020385009	MTG 10 Baskısız	Boş / Empty	25	250	83,59	3,3436
8020385029	MTG 10 (1)	1	25	250	102,31	4,0924
8020385039	MTG 10 (2)	2	25	250	102,31	4,0924
8020385049	MTG 10 (3)	3	25	250	102,31	4,0924
8020385059	MTG 10 (4)	4	25	250	102,31	4,0924
8020385069	MTG 10 (5)	5	25	250	102,31	4,0924
8020385079	MTG 10 (6)	6	25	250	102,31	4,0924
8020385089	MTG 10 (7)	7	25	250	102,31	4,0924
8020385099	MTG 10 (8)	8	25	250	102,31	4,0924
8020385109	MTG 10 (9)	9	25	250	102,31	4,0924
8020385119	MTG 10 (10)	10	25	250	102,31	4,0924
8020385129	MTG 10 (RSTN)	RSTN	25	250	102,31	4,0924
8020385139	MTG 10 (L1)	L1	25	250	102,31	4,0924
8020385149	MTG 10 (L2)	L2	25	250	102,31	4,0924
8020385159	MTG 10 (L3)	L3	25	250	102,31	4,0924

tbloc

klemens aksesuar seçim tablosu

terminal block accessory selection table

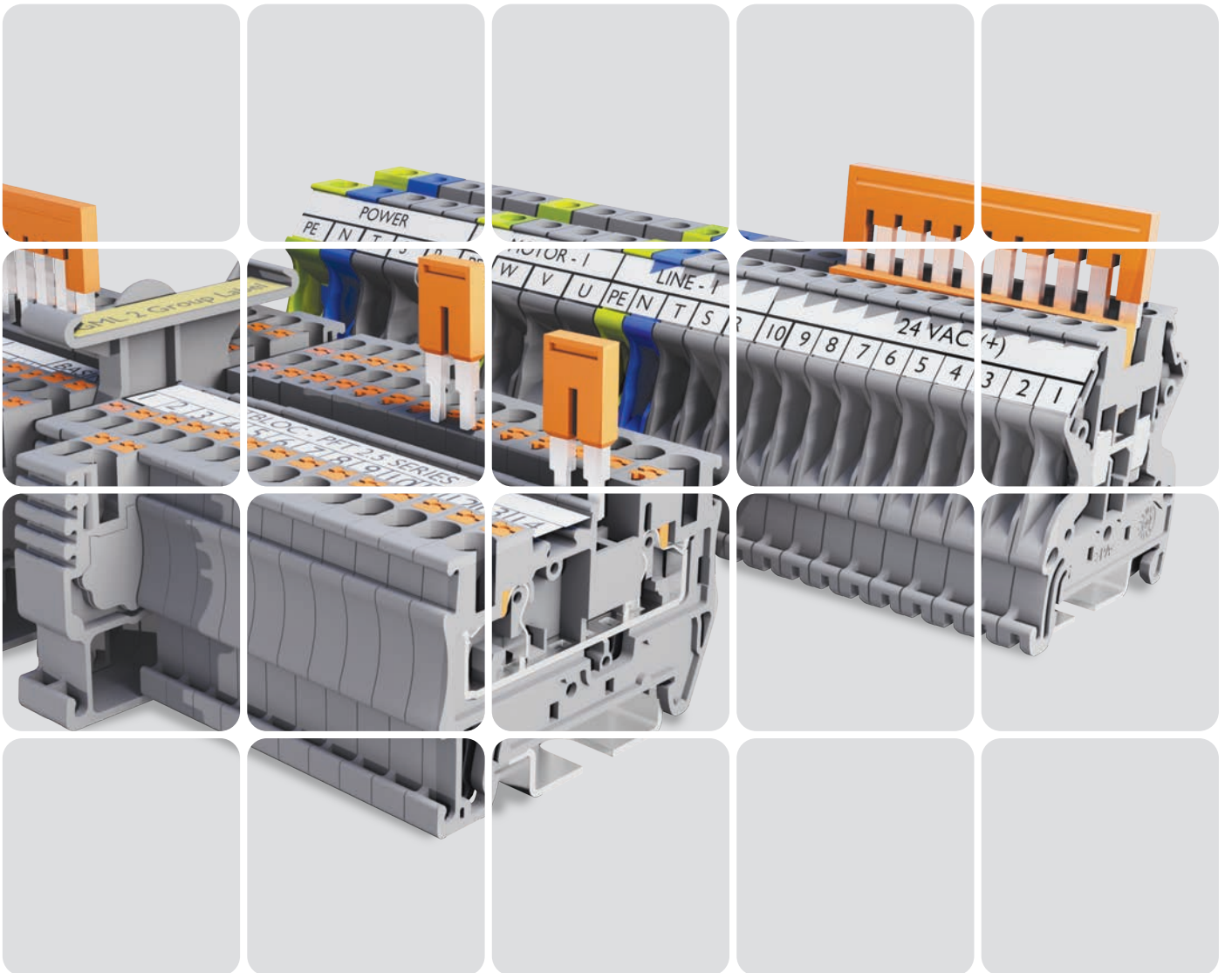

Klemensler Terminals Blocks	Klemens Code List	Nihayet Plakası End Plate	Ayırma Plakası Separation Plate	Ayırma Dili Small Partitation Plate	Üst Köprü Cross Connections	Kayar Köprü
TBL 2,5	8000099008	8012396118-EPL TBL 2,5-10	PR TBL 2,5 - 10 8012396408	8012396528 - SPR 2,5-10	8013095023 - SCC 2,5/2 8013095033 - SCC 2,5/3 8013095003 - SCC 2,5/10	---
TBL 4	8000099028	8012396118-EPL TBL 2,5-10	PR TBL 2,5 - 10 8012396408	8012396528 - SPR 2,5-10	SCC 4/2 8013095123 SCC 4/3 8013095133 SCC 4/10 8013095103	---
TBL 6	8000099038	8012396118-EPL TBL 2,5-10	PR TBL 2,5 - 10 8012396408	8012396528 - SPR 2,5-10	8013095223 - SCC 6/2 8013095233 - SCC 6/3 8013095203 - SCC 6/10	---
TBL 10	8000099048	8012396118-EPL TBL 2,5-10	PR TBL 2,5 - 10 8012396408	8012396528 - SPR 2,5-10	8013095323 - SCC 10/2 8013095333 - SCC 10/3 8013095303 - SCC 10/10	---
TBL 16	8000099058	---	8012396568 - GPR	---	8013095423 - SCC 16/2 8013095433 - SCC 16/3 8013095403 - SCC 16/10	---
TBL 25	8000099068	---	8012396568 - GPR	---	8013095523 - SCC 25/2 8013095533 - SCC 25/3 8013095503 - SCC 25/10	---
TBL 35	8000099078	---	8012396568 - GPR	---	8013095623 - SCC 35/2 8013095633 - SCC 35/3 8013095603 - SCC 35/10	---
TBL 50	8000099088	---	8012396568 - GPR	---	SCC 50/2 8013095723 SCC 50 /3 8013095733	---
TBL 70	8000099098	---	8012396568 - GPR	---	SCC 70/2 8013095823 SCC 70 /3 8013095833	---
TBL 95	8000099108	---	---	---	8013095923 - SCC 95/2 8013095933 - SCC 95/3	---
TBL 150	8000099116	---	---	---	SCC 150/2 8013094023	---
NTT 2,5 E	8001099214	8012396118-EPL TBL 2,5-10	---	---	---	---
NTT 4 E	8001099224	8012396118-EPL TBL 2,5-10	---	---	---	---
NTT 6 E	8001099234	8012396118-EPL TBL 2,5-10	---	---	---	---
NTT 10 E	8001099244	8012396118-EPL TBL 2,5-10	---	---	---	---
TBL 16 E	8001099194	---	---	---	---	---
TBL 35 E	8001099204	---	---	---	---	---
TBL 2,5-4 2P	8002099438	8012396208 - EPL TBL 2,5-4 2P	PR TBL 4 2P 8012396508	SPR TBL 4 2P 8012396558	8013095023 - SCC 2,5/2 8013095033 - SCC 2,5/3 8013095003 - SCC 2,5/10	---
TBL 4 2P	8002099258	8012396218-EPL1 TBL 4 2P 8012396228-EPL2 TBL 4 2P 8012396238 - EPL3 TBL 4 2P	8012396568 - GPR	---	8013094103 - SCC 4/10 TBL 4 2P 8013094123 - SCC 4/2 TBL 4 2P 8013094133 - SCC 4/3 TBL 4 2P	---
TBL 2,5-4 2PK	8002099448	8012396208 - EPL TBL 2,5-4 2P	8012396568 - GPR	---	8013094103 - SCC 4/10 TBL 4 2P 8013094123 - SCC 4/2 TBL 4 2P 8013094133 - SCC 4/3 TBL 4 2P	---

Tarak Köprü Comb Connector	Test Fişi Test Socket	Durdurucu Stopper	Şerit Etiket Strip Label	Etiket Marking Tags	Ray DIN Rail	Kapak Cover
---	8014393227 - TST 1	8010097308 - SS 1 8010097318 - SS 2 8010197328 - PS 1	---	8020388009 - MTG 6 Boş	8015393407 - DR 35-7,5 S 2M 8015393427 - DR 35-15 S 2M	---
8013094323 - TCC 4/2 8013094333 - TCC 4/3 8013094303 - TCC 4/10	8014393227 - TST 1	8010097308 - SS 1 8010097318 - SS 2 8010197328 - PS 1	---	8020387009 - MTG 6,4 Boş	8015393407 - DR 35-7,5 S 2M 8015393427 - DR 35-15 S 2M	---
8013394823 - TCC 6/2 8013394833 - TCC 6/3 8013394803 TCC 6/10	8014393108 - TST-I1	8010097308 - SS 1 8010097318 - SS 2 8010197328 - PS 1	---	8020386009 - MTG 8 Boş	8015393407 - DR 35-7,5 S 2M 8015393427 - DR 35-15 S 2M	---
---	8014393108 - TST-I1 8014393237 - TST 2	8010097308 - SS 1 8010097318 - SS 2 8010197328 - PS 1	---	8020385009 - MTG 10 Boş	8015393407 - DR 35-7,5 S 2M 8015393427 - DR 35-15 S 2M	---
---	8014393247 - TST 3	8010097308 - SS 1 8010097318 - SS 2 8010197328 - PS 1	---	8020385009 - MTG 10 Boş	8015393407 - DR 35-7,5 S 2M 8015393427 - DR 35-15 S 2M	---
---	8014393257 - TST 4	8010097308 - SS 1 8010097318 - SS 2 8010197328 - PS 1	---	8020385009 - MTG 10 Boş	8015393407 - DR 35-7,5 S 2M 8015393427 - DR 35-15 S 2M	---
---	8014393257 - TST 4	8010097308 - SS 1 8010097318 - SS 2 8010197328 - PS 1	---	8020385009 - MTG 10 Boş	8015393407 - DR 35-7,5 S 2M 8015393427 - DR 35-15 S 2M	---
---	---	8010097308 - SS 1 8010097318 - SS 2 8010197328 - PS 1	---	8020385009 - MTG 10 Boş	8015393407 - DR 35-7,5 S 2M 8015393427 - DR 35-15 S 2M	---
---	---	8010097308 - SS 1 8010097318 - SS 2 8010197328 - PS 1	---	8020385009 - MTG 10 Boş	8015393407 - DR 35-7,5 S 2M 8015393427 - DR 35-15 S 2M	---
---	---	8010097308 - SS 1 8010097318 - SS 2 8010197328 - PS 1	---	8020385009 - MTG 10 Boş	8015393407 - DR 35-7,5 S 2M 8015393427 - DR 35-15 S 2M	---
---	---	8010097308 - SS 1 8010097318 - SS 2 8010197328 - PS 1	---	8020385009 - MTG 10 Boş	8015393407 - DR 35-7,5 S 2M 8015393427 - DR 35-15 S 2M	---
---	---	---	---	MTG 6 8020388009	8015393407 - DR 35-7,5 S 2M 8015393427 - DR 35-15 S 2M	---
---	---	---	---	MTG 6,4 8020387009	8015393407 - DR 35-7,5 S 2M 8015393427 - DR 35-15 S 2M	---
---	---	---	---	MTG 8 8020386009	8015393407 - DR 35-7,5 S 2M 8015393427 - DR 35-15 S 2M	---
---	---	---	---	MTG 10 8020385009	8015393407 - DR 35-7,5 S 2M 8015393427 - DR 35-15 S 2M	---
---	---	---	---	MTG 10 8020385009	8015393407 - DR 35-7,5 S 2M 8015393427 - DR 35-15 S 2M	---
---	---	---	---	MTG 10 8020385009	8015393407 - DR 35-7,5 S 2M 8015393427 - DR 35-15 S 2M	---
---	8014393227 - TST 1	8010097308 - SS 1 8010097318 - SS 2 8010197328 - PS 1	---	8020388009 - MTG 6 Boş	8015393407 - DR 35-7,5 S 2M 8015393427 - DR 35-15 S 2M	---
---	8014393227 - TST 1	8010097308 - SS 1 8010097318 - SS 2 8010197328 - PS 1	---	8020387009 - MTG 6,4 Boş	8015393407 - DR 35-7,5 S 2M 8015393427 - DR 35-15 S 2M	---
---	8014393227 - TST 1	8010097308 - SS 1 8010097318 - SS 2 8010197328 - PS 1	---	8020388009 - MTG 6 Boş	8015393407 - DR 35-7,5 S 2M 8015393427 - DR 35-15 S 2M	---

Klemensler Terminals Blocks	Klemens Code List	Nihayet Plakası End Plate	Ayrırma Plakası Separation Plate	Ayrırma Dili Small Partitation Plate	Üst Köprü Cross Connections	Kayar Köprü
TBL 2,5-4 2PL (24-48VAC/DC)	8002099458	8012396208 - EPL TBL 2,5-4 2P	8012396568 - GPR	---	---	---
TBL 2,5-4 2PL (110-220VAC/DC)	8002099468	8012396208 - EPL TBL 2,5-4 2P	8012396568 - GPR	---	---	---
TBL 4 2P X1, X2, X3, X4, X5, X6, X7, X8	8002099268 8002099278 8002099288 8002099298 8002099318 8002099305 8002099328 8002099338 8002099348	8012396218 - EPL1 TBL 4 2P 8012396228 - EPL2 TBL 4 2P 8012396238 - EPL3 TBL 4 2P	---	8012396558 - SPR TBL 4 2P	---	---
TBL 4 2PL (24-48VAC/DC)	8002099368	8012396218 - EPL1 TBL 4 2P 8012396228 - EPL2 TBL 4 2P 8012396238 - EPL3 TBL 4 2P	---	8012396558 - SPR TBL 4 2P	---	---
TBL 4 2PL (110-220VAC/DC)	8002099378	8012396218 - EPL1 TBL 4 2P 8012396228 - EPL2 TBL 4 2P 8012396238 - EPL3 TBL 4 2P	---	8012396558 - SPR TBL 4 2P	---	---
TBL 4 2PK	8002099428	8012396218 - EPL1 TBL 4 2P 8012396228 - EPL2 TBL 4 2P 8012396238 - EPL3 TBL 4 2P	---	8012396558 - SPR TBL 4 2P	---	---
TBL 4 3P	8002099478	---	8012396568 - GPR	---	8013094103 - SCC 4/10 TBL 4 2P 8013094123 - SCC 4/2 TBL 4 2P 8013094133 - SCC 4/3 TBL 4 2P	---
TBL 2,5 S	8003099528	---	---	---	---	---
FDT 4 L (24-48 VAC/DC)	8003099498	---	---	---	---	---
FDT 4 L (110-220 VAC/DC)	8003099508	---	---	---	---	---
FDT 4 L (24-48 VAC/DC)	8003099496	---	---	---	---	---
FDT 4 L (110-220 VAC/DC)	8003099506	---	---	---	---	---
FDT 4 L (110-220 VAC)	8003099518	---	---	---	---	---
TDT-C 6	8004099808	---	---	---	---	8013394923 - SLC2 8013394933 - SLC 3 8013394943 - SLC 4
TDT-V 6	8004099818	---	---	---	---	8013394923 - SLC 2 8013394933 - SLC 3, 8013394943 - SLC 4
TDS-C 6	8004099828	8012396018 - EPL TDS	---	---	---	8013394923 - SLC 2 8013394933 - SLC 3 8013394943 - SLC 4
TDV-C 6	8004099838	8012396028 - EPL TDV	---	---	---	---
TDS-V 6	8004099848	8012396018 - EPL TDS	---	---	---	8013394923 - SLC 2 8013394933 - SLC 3 8013394943 - SLC 4
TDY-C 6	8004099858	8012396038 - EPL TDY	---	---	---	8014393307 - SLC-R 2 8014393317 - SLC-R 3 8014393327 - SLC-R 4

Tarak Köprü Comb Connector	Test Fişi Test Socket	Durdurucu Stopper	Şerit Etiket Strip Label	Etiket Marking Tags	Ray DIN Rail	Kapak Cover
---	8014393227 - TST 1	8010097308 - SS 1 8010097318 - SS 2 8010197328 - PS 1	---	8020388009 - MTG 6 Boş	8015393407 - DR 35-7,5 S 2M 8015393427 - DR 35-15 S 2M	---
---	8014393227 - TST 1	8010097308 - SS 1 8010097318 - SS 2 8010197328 - PS 1	---	8020388009 - MTG 6 Boş	8015393407 - DR 35-7,5 S 2M 8015393427 - DR 35-15 S 2M	---
---	8014393227 - TST 1	8010097308 - SS 1 8010097318 - SS 2 8010197328 - PS 1	---	8020387009 - MTG 6,4 Boş	8015393407 - DR 35-7,5 S 2M 8015393427 - DR 35-15 S 2M	---
---	8014393227 - TST 1	8010097308 - SS 1 8010097318 - SS 2 8010197328 - PS 1	---	8020387009 - MTG 6,4 Boş	8015393407 - DR 35-7,5 S 2M 8015393427 - DR 35-15 S 2M	---
---	8014393227 - TST 1	8010097308 - SS 1 8010097318 - SS 2 8010197328 - PS 1	---	8020387009 - MTG 6,4 Boş	8015393407 - DR 35-7,5 S 2M 8015393427 - DR 35-15 S 2M	---
---	8014393227 - TST 1	8010097308 - SS 1 8010097318 - SS 2 8010197328 - PS 1	---	8020387009 - MTG 6,4 Boş	8015393407 - DR 35-7,5 S 2M 8015393427 - DR 35-15 S 2M	---
---	---	8010097308 - SS 1 8010097318 - SS 2 8010197328 - PS 1	---	8020388009 - MTG 6 Boş	8015393407 - DR 35-7,5 S 2M 8015393427 - DR 35-15 S 2M	---
8013394823 - TCC 6/2 8013394833 - TCC 6/3 8013394803 TCC 6/10	---	8010097308 - SS 1 8010097318 - SS 2 8010197328 - PS 1	---	8020386009 - MTG 8 Boş	8015393407 - DR 35-7,5 S 2M 8015393427 - DR 35-15 S 2M	---
8013394823 - TCC 6/2 8013394833 - TCC 6/3 8013394803 TCC 6/10	---	8010097308 - SS 1 8010097318 - SS 2 8010197328 - PS 1	---	8020386009 - MTG 8 Boş	8015393407 - DR 35-7,5 S 2M 8015393427 - DR 35-15 S 2M	---
8013394823 - TCC 6/2 8013394833 - TCC 6/3 8013394803 TCC 6/10	---	8010097308 - SS 1 8010097318 - SS 2 8010197328 - PS 1	---	8020386009 - MTG 8 Boş	8015393407 - DR 35-7,5 S 2M 8015393427 - DR 35-15 S 2M	---
8013394823 - TCC 6/2 8013394833 - TCC 6/3 8013394803 TCC 6/10	---	8010097308 - SS 1 8010097318 - SS 2 8010197328 - PS 1	---	8020386009 - MTG 8 Boş	8015393407 - DR 35-7,5 S 2M 8015393427 - DR 35-15 S 2M	---
8013394823 - TCC 6/2 8013394833 - TCC 6/3 8013394803 TCC 6/10	8014393108 - TST-11	8010097308 - SS 1 8010097318 - SS 2 8010197328 - PS 1	---	8020386009 - MTG 8 Boş	8015393407 - DR 35-7,5 S 2M 8015393427 - DR 35-15 S 2M	---
8013394823 - TCC 6/2 8013394833 - TCC 6/3 8013394803 TCC 6/10	8014393108 - TST-11	8010097308 - SS 1 8010097318 - SS 2 8010197328 - PS 1	---	8020386009 - MTG 8 Boş	8015393407 - DR 35-7,5 S 2M 8015393427 - DR 35-15 S 2M	---
8013394823 - TCC 6/2 8013394833 - TCC 6/3 8013394803 TCC 6/10	8014393108 - TST-11	8010097308 - SS 1 8010097318 - SS 2 8010197328 - PS 1	---	8020386009 - MTG 8 Boş	8015393407 - DR 35-7,5 S 2M 8015393427 - DR 35-15 S 2M	---
8013394823 - TCC 6/2 8013394833 - TCC 6/3 8013394803 TCC 6/10	---	8010097308 - SS 1 8010097318 - SS 2 8010197328 - PS 1	---	8020386009 - MTG 8 Boş	8015393407 - DR 35-7,5 S 2M 8015393427 - DR 35-15 S 2M	---
8013394823 - TCC 6/2 8013394833 - TCC 6/3 8013394803 TCC 6/10	8014393108 - TST-11	8010097308 - SS 1 8010097318 - SS 2 8010197328 - PS 1	---	8020386009 - MTG 8 Boş	8015393407 - DR 35-7,5 S 2M 8015393427 - DR 35-15 S 2M	---
8013394823 - TCC 6/2 8013394833 - TCC 6/3 8013394803 TCC 6/10	8014393108 - TST-11	8010097308 - SS 1 8010097318 - SS 2 8010197328 - PS 1	---	8020386009 - MTG 8 Boş	8015393407 - DR 35-7,5 S 2M 8015393427 - DR 35-15 S 2M	---

Klemensler Terminals Blocks	Klemens Code List	Nihayet Plakası End Plate	Ayırma Plakası Seperation Plate	Ayırma Dili Smal Partitation Plate	Üst Köprü Cross Connections	Kayar Köprü
PFT 2,5	8000298008	---	---	---	8013294523 - PCC 2,5/2 8013294533 - PCC 2,5/3 8013294503 - PCC 2,5/10	---
PFT 4	8000298018	---	---	---	PCC 4/2 8013294623 PCC 4/3 8013294633 PCC 4/10 8013294603	---
PFT 6	8000298028	---	---	---	PCC 6/2 8013294723 PCC 6/3 8013294733 PCC 6/10 8013294703	---
PFT 10	8000298038	---	---	---	PCC 10/2 8013294823 PCC 10/3 8013294833	---
PFT 2,5 E	8001298064	---	---	---	---	---
PFT 4 E	8001298074	---	---	---	---	---
PFT 6 E	8001298084	---	---	---	---	---
PFT 10 E	8001298104	---	---	---	PCC 10/2 8013294823 PCC 10/3 8013294833	---
PFT 2,5 1X2	8000298068	---	---	---	8013294523 - PCC 2,5/2 8013294533 - PCC 2,5/3 8013294503 - PCC 2,5/10	---
PFT 2,5 1X2	8000298060	---	---	---	8013294523 - PCC 2,5/2 8013294533 - PCC 2,5/3 8013294503 - PCC 2,5/10	---
PFT 2,5 2X2	8000298078	---	---	---	8013294523 - PCC 2,5/2 8013294533 - PCC 2,5/3 8013294503 - PCC 2,5/10	---
PFT 2,5 2P	8002298098	---	---	---	8013294523 - PCC 2,5/2 8013294533 - PCC 2,5/3 8013294503 - PCC 2,5/10	---
PFT 2,5 2P+E	8002298108	---	---	---	8013294523 - PCC 2,5/2 8013294533 - PCC 2,5/3 8013294503 - PCC 2,5/10	---
PFT 4 2P	8002298118	---	---	---	PCC 4/2 8013294623 PCC 4/3 8013294633 PCC 4/10 8013294603	---
TBB 70	8000099128	---	---	---	---	---
TBB 95	8000099138	---	---	---	---	---
TBB 150	8000099148	---	---	---	---	---
TBB 240	8000099158	---	---	---	---	---

Tarak Köprü Comb Connector	Test Fişi Test Socket	Durdurucu Stopper	Şerit Etiket Strip Label	Etiket Marking Tags	Ray DIN Rail	Kapak Cover
---	---	8010097308 - SS 1 8010097318 - SS 2 8010197328 - PS 1	8020384009 - TBSL 22X20	8020389009 - MTG 5 Boş	8015393407 - DR 35-7,5 S 2M 8015393427 - DR 35-15 S 2M	---
---	---	8010097308 - SS 1 8010097318 - SS 2 8010197328 - PS 1	8020384009 - TBSL 22X20	MTG 6 8020388009	8015393407 - DR 35-7,5 S 2M 8015393427 - DR 35-15 S 2M	---
---	---	8010097308 - SS 1 8010097318 - SS 2 8010197328 - PS 1	8020384009 - TBSL 22X20	MTG 8 8020386009	8015393407 - DR 35-7,5 S 2M 8015393427 - DR 35-15 S 2M	---
---	---	8010097308 - SS 1 8010097318 - SS 2 8010197328 - PS 1	8020384009 - TBSL 22X20	MTG 10 8020385009	8015393407 - DR 35-7,5 S 2M 8015393427 - DR 35-15 S 2M	---
---	---	8010097308 - SS 1 8010097318 - SS 2 8010197328 - PS 1	8020384009 - TBSL 22X20	8020389009 - MTG 5 Boş	8015393407 - DR 35-7,5 S 2M 8015393427 - DR 35-15 S 2M	---
---	---	8010097308 - SS 1 8010097318 - SS 2 8010197328 - PS 1	8020384009 - TBSL 22X20	MTG 6 8020388009	8015393407 - DR 35-7,5 S 2M 8015393427 - DR 35-15 S 2M	---
---	---	8010097308 - SS 1 8010097318 - SS 2 8010197328 - PS 1	8020384009 - TBSL 22X20	MTG 8 8020386009	8015393407 - DR 35-7,5 S 2M 8015393427 - DR 35-15 S 2M	---
---	---	8010097308 - SS 1 8010097318 - SS 2 8010197328 - PS 1	8020384009 - TBSL 22X20	MTG 10 8020385009	8015393407 - DR 35-7,5 S 2M 8015393427 - DR 35-15 S 2M	---
---	---	8010097308 - SS 1 8010097318 - SS 2 8010197328 - PS 1	8020384009 - TBSL 22X20	8020389009 - MTG 5 Boş	8015393407 - DR 35-7,5 S 2M 8015393427 - DR 35-15 S 2M	---
---	---	8010097308 - SS 1 8010097318 - SS 2 8010197328 - PS 1	8020384009 - TBSL 22X20	8020389009 - MTG 5 Boş	8015393407 - DR 35-7,5 S 2M 8015393427 - DR 35-15 S 2M	---
---	---	8010097308 - SS 1 8010097318 - SS 2 8010197328 - PS 1	8020384009 - TBSL 22X20	8020389009 - MTG 5 Boş	8015393407 - DR 35-7,5 S 2M 8015393427 - DR 35-15 S 2M	---
---	---	8010097308 - SS 1 8010097318 - SS 2 8010197328 - PS 1	8020384009 - TBSL 22X20	8020389009 - MTG 5 Boş	8015393407 - DR 35-7,5 S 2M 8015393427 - DR 35-15 S 2M	---
---	---	8010097308 - SS 1 8010097318 - SS 2 8010197328 - PS 1	8020384009 - TBSL 22X20	8020389009 - MTG 5 Boş	8015393407 - DR 35-7,5 S 2M 8015393427 - DR 35-15 S 2M	---
---	---	8010097308 - SS 1 8010097318 - SS 2 8010197328 - PS 1	8020384009 - TBSL 22X20	8020389009 - MTG 5 Boş	8015393407 - DR 35-7,5 S 2M 8015393427 - DR 35-15 S 2M	---
---	---	8010097308 - SS 1 8010097318 - SS 2 8010197328 - PS 1	8020384009 - TBSL 22X20	8020389009 - MTG 5 Boş	8015393407 - DR 35-7,5 S 2M 8015393427 - DR 35-15 S 2M	---
---	---	8010097308 - SS 1 8010097318 - SS 2 8010197328 - PS 1	8020384009 - TBSL 22X20	MTG 6 8020388009	8015393407 - DR 35-7,5 S 2M 8015393427 - DR 35-15 S 2M	---
---	---	8010097308 - SS 1 8010097318 - SS 2 8010197328 - PS 1	---	8020389009 - MTG 5 Boş	8015393407 - DR 35-7,5 S 2M 8015393427 - DR 35-15 S 2M	C-TBB 70-95-150
---	---	8010097308 - SS 1 8010097318 - SS 2 8010197328 - PS 1	---	8020389009 - MTG 5 Boş	8015393407 - DR 35-7,5 S 2M 8015393427 - DR 35-15 S 2M	C-TBB 70-95-150
---	---	8010097308 - SS 1 8010097318 - SS 2 8010197328 - PS 1	---	8020389009 - MTG 5 Boş	8015393407 - DR 35-7,5 S 2M 8015393427 - DR 35-15 S 2M	C-TBB 70-95-150
---	---	8010097308 - SS 1 8010097318 - SS 2 8010197328 - PS 1	---	8020389009 - MTG 5 Boş	8015393407 - DR 35-7,5 S 2M 8015393427 - DR 35-15 S 2M	C-TBB 240

Elektrolitik beyaz krom kaplanmış galvaniz çelik malzeme
Electrolytic white chromated & galvanized steel material
EN 50022 EN 50035 IEC 60715

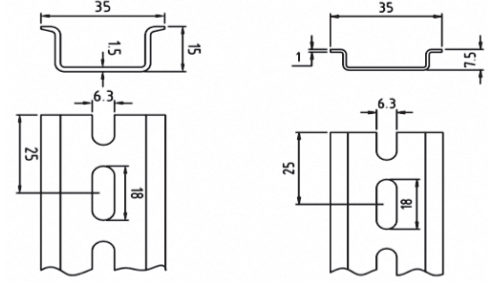

Montaj Rayları

Mounting Rails

Ürün Kodu Product Code	Ürün Adı Product Name	Ölçüler / Dimensions (mm)		Açıklama Explanation	Birim Uzunluk Unit Length (m)	Ambalaj Miktarı Package Qty (metre/meter)	Birim Fiyatı Unit Price (TL/mt.)
		W	H				
8015393407	DR 35-7,5 S 2M	35	7,5	Delikli Din Normu Ray / Slotted Din Rail	2	40	205,400
8015393427	DR 35-15 S 2M	35	15	Delikli Din Normu Ray / Slotted Din Rail	2	20	416,000

Eko Seri Montaj Rayları

Economical Range Mounting Rails

Ürün Kodu Product Code	Ürün Adı Product Name	Ölçüler / Dimensions (mm)		Açıklama Explanation	Birim Uzunluk Unit Length (m)	Ambalaj Miktarı Package Qty (metre/meter)	Birim Fiyatı Unit Price (TL/mt.)
		W	H				
8015393447	DR 35-7,5 E 2M	35	7,5	Delikli Din Normu Ray / Slotted Din Rail	2	50	117,000

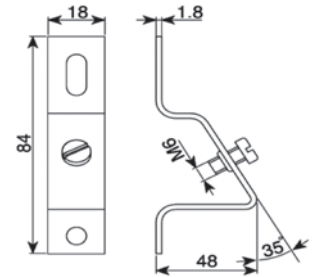

Ray Taşıyıcılar ve Kapakları

Rail Supports and Covers

Ürün Kodu Product Code	Ürün Adı Product Name	Açıklama Explanation	Delik Çapı Dia. Hole	Ambalaj Miktarı Package Qty (Adet/pcs.)	Birim Fiyatı Unit Price (TL/Adet)
8015393507	ART - M6	35° Açılı Ray Taşıyıcı / 35° Angeled Rail Support	M6	10	32,500
8015393537	C-DR 7,5	Ray Kenar Kapağı / Rail Cover	--	200	0,546
8015393547	C-DR 15	Ray Kenar Kapağı / Rail Cover	--	100	1,092



WDC 125

Kanal Kesme Makası

Wiring Duct Cutter

Ürün Kodu Product Code	Ürün Adı Product Name	Açıklama Explanation	Ambalaj Miktarı Package Qty (Adet/pcs.)	Birim Fiyatı Unit Price (TL/Adet)
8019391300	WDC 125	125 mm genişliğe kadar kablo kanalları için Düz kesim tezgah üstü makas. Flat-cut Table-top type cutter up to 120 mm duct width	1	Sorunuz

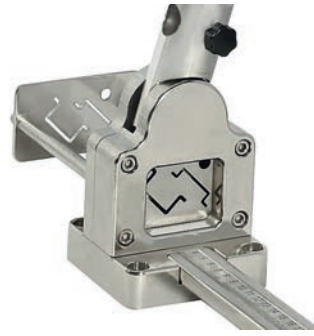

DRC 2W8R

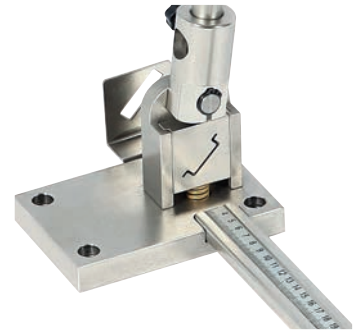

DRC 1W

Ray Kesme Makasları

Din Rail Cutters

Ürün Kodu Product Code	Ürün Adı Product Name	Açıklama Explanation	Ambalaj Miktarı Package Qty (Adet/pcs.)	Birim Fiyatı Unit Price (TL/Adet)
8015393557	DRC 1W	35x7.5 raya uygun, 1.5 mm kalınlığa kadar kesim, 1 gözlü tezgah üstü makas. 1 way table-top type cutter for 35x7.5 Din Rail, up to 1.5 mm thickness	1	Sorunuz
8015393567	DRC 2W8R	35x7.5, 35x15 raya ve 8 mm Tij kesimine uygun, 3 gözlü tezgah üstü makas. 3 way table-top type cutter for 35x7.5, 35x15 Din Rails and 8 mm Rod	1	Sorunuz

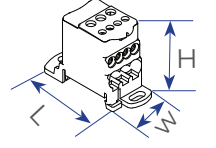

Dağıtım Blokları SDB Serisi

Distribution Blocks SDB Series

Ürün Kodu Product Code	Ürün Adı Product Name	Açıklama Explanation	Ebatlar Dimension (mm ²)	Voltaj Voltage	Amper Current	Amb. Mik. Pack. Qty (Adet/Pcs.)	Birim Fiyatı Unit Price (TL/Adet)
8037000100	SDB 80 A	Dağıtım Blokları / Distribution Blocks	66x27x46	1000 V	80 A	1	221,000
8037000110	SDB 125 A	Dağıtım Blokları / Distribution Blocks	77x29x46	1000 V	125 A	1	455,000
8037000120	SDB 160 A	Dağıtım Blokları / Distribution Blocks	77x29x46	1000 V	160 A	1	468,000
8037000130	SDB 250A	Dağıtım Blokları / Distribution Blocks	96x46x50	1000 V	250 A	1	1.300,000
8037000140	SDB 400 A	Dağıtım Blokları / Distribution Blocks	96x46x50	1000 V	400 A	1	1.430,000
8037000150	SDB 500 A	Dağıtım Blokları / Distribution Blocks	96x46x50	1000 V	500 A	1	1.625,000

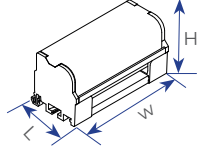

Dağıtım Blokları TDB Serisi

Distribution Blocks TDB Series

Ürün Kodu Product Code	Ürün Adı Product Name	Açıklama Explanation	Ebatlar Dimension (mm ²)	Voltaj Voltage	Amper Current	Amb. Mik. Pack. Qty (Adet/Pcs.)	Birim Fiyatı Unit Price (TL/Adet)
8037000220	TDB 2 x7-100A	Dağıtım Blokları / Distribution Blocks	50x64x50	1000 V	100 A	1	260,000
8037000230	TDB 2 x 7 - 125 A	Dağıtım Blokları / Distribution Blocks	50x64x50	500 V	125 A	1	312,000
8037000210	TDB 2 x 8-80A	Dağıtım Blokları / Distribution Blocks	50x64x50	500 V	80 A	1	260,000
8037000221	TDB 2 x 11-100A	Dağıtım Blokları / Distribution Blocks	50x100x50	500 V	100 A	1	494,000
8037000231	TDB 2 x 11-125A	Dağıtım Blokları / Distribution Blocks	50x100x50	500 V	125 A	1	377,000
8037000232	TDB 2 x 15-125A	Dağıtım Blokları / Distribution Blocks	50x130x50	500 V	125 A	1	487,500
8037000211	TDB 2 x 18-80A	Dağıtım Blokları / Distribution Blocks	50x130x50	500 V	80 A	1	650,000

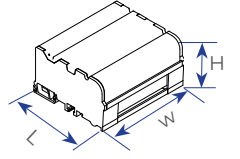

Dağıtım Blokları TDB Serisi

Distribution Blocks TDB Series

Ürün Kodu Product Code	Ürün Adı Product Name	Açıklama Explanation	Ebatlar Dimension (mm ²)	Voltaj Voltage	Amper Current	Amb. Mik. Pack. Qty (Adet/Pcs.)	Birim Fiyatı Unit Price (TL/Adet)
8037000320	FDB 4 x 7-100A	Dağıtım Blokları / Distribution Blocks	90x64x50	1000 V	100 A	1	494,000
8037000330	FDB 4 x 7-125A	Dağıtım Blokları / Distribution Blocks	90x64x50	500 V	125 A	1	585,000
8037000310	FDB 4 x 8-80A	Dağıtım Blokları / Distribution Blocks	90x64x50	500 V	80 A	1	520,000
8037000321	FDB 4 x 11-100A	Dağıtım Blokları / Distribution Blocks	90x100x50	500 V	100 A	1	741,000
8037000331	FDB 4 x 11-125A	Dağıtım Blokları / Distribution Blocks	90x100x50	500 V	125 A	1	754,000
8037000332	FDB 4 x 15-125A	Dağıtım Blokları / Distribution Blocks	90x130x50	500 V	125 A	1	936,000
8037000312	FDB 4 x 18-80A	Dağıtım Blokları / Distribution Blocks	90x130x50	500 V	80 A	1	975,000

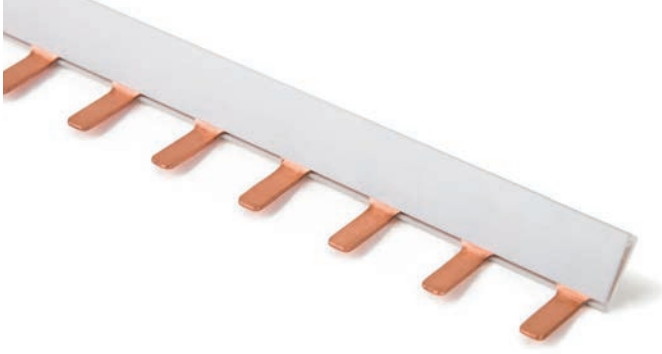

Monofaze W Otomat Baraları

Singlephase MCB Busbars

Ürün Kodu Product Code	Ürün Adı Product Name	Akım Current (A)	Bara Kalınlığı Busbar Thickness (mm)	Uzunluk Length (cm.)	Modül Sayısı Module Number	Ambalaj Mik. Pack. Qty. (TL/Ad.)	Birim Fiyatı Unit Price (TL/Ad.)
8034110010	MJAB80-1x53	80	1	53	30	50	299,000
8034110020	MJAB80-1x106	80	1	106	60	50	598,000
8034110030	MJAB100-1,5x53	100	1.5	53	30	50	416,000
8034110040	MJAB100-1,5x106	100	1.5	106	60	50	832,000

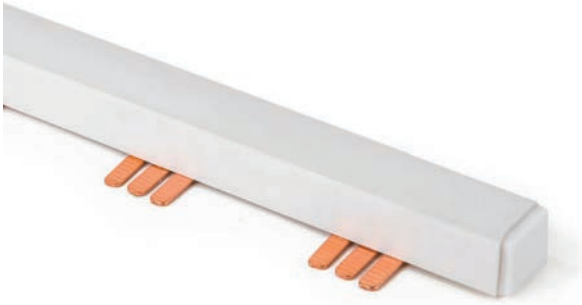

Trifaze W Otomat Baraları

Threephases MCB Busbars

Ürün Kodu Product Code	Ürün Adı Product Name	Akım Current (A)	Bara Kalınlığı Busbar Thickness (mm)	Uzunluk Length (cm.)	Modül Sayısı Module Number	Ambalaj Mik. Pack. Qty. (TL/Ad.)	Birim Fiyatı Unit Price (TL/Ad.)
8034330010	TJAB63- 1x53	63	1	53	10	25	715,000
8034330020	TJAB63- 1x106	63	1	106	20	25	1.430,000
8034330030	TJAB80- 1x53	80	1	53	10	25	780,000
8034330040	TJAB80- 1x106	80	1	106	20	25	1.560,000
8034330050	TJAB100-1,5x53	100	1.5	53	10	25	1.170,000
8034330060	TJAB100-1,5x106	100	1.5	106	20	25	2.340,000

W Otomat Bara Kapakları

MCB Busbar Side Covers

Ürün Kodu Product Code	Ürün Adı Product Name	Ambalaj Mik. Pack. Qty. (TL/Ad.)	Birim Fiyatı Unit Price (TL/Ad.)
8034110009	Monofaze otomat barası kapagi / Singlephase mcb busbar side covers	500	11,700
8034330009	Trifaze otomat barası kapagi / Threephases mcb busbar side covers	500	11,700

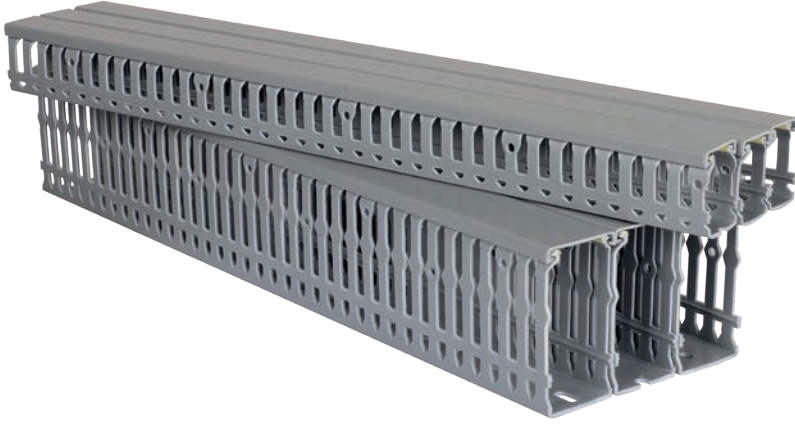

Kendini söndürebilen sert PVC malzeme
Self-extinguishing rigid PVC material
EN 50085-1+A
EN 50085-2-3
IEC 60695-2-11



Delikli Kablo Kanalları

Slotted Wiring Ducts

Ürün Kodu Product Code	Ürün Adı Product Name	Ölçüler / Dimensions (mm)		Renk Color	Ambalaj Miktarı Package Qty (metre/meter)	Birim Fiyatı Unit Price (TL/mt.)
		W	H			
8019391008	SWD 25X40 Pano Tipi Kablo Kanalı	25	40	Gri / Grey	60	130,000
8019391018	SWD 25X60 Pano Tipi Kablo Kanalı	25	60	Gri / Grey	40	175,500
8019391318	SWD 25X80 Pano Tipi Kablo Kanalı	25	80	Gri / Grey	20	243,100
8019391028	SWD 40X40 Pano Tipi Kablo Kanalı	40	40	Gri / Grey	40	178,100
8019391038	SWD 40X60 Pano Tipi Kablo Kanalı	40	60	Gri / Grey	36	210,600
8019391048	SWD 40X80 Pano Tipi Kablo Kanalı	40	80	Gri / Grey	28	267,800
8019391058	SWD 60X40 Pano Tipi Kablo Kanalı	60	40	Gri / Grey	32	205,400
8019391068	SWD 60X60 Pano Tipi Kablo Kanalı	60	60	Gri / Grey	24	279,500
8019391078	SWD 60X80 Pano Tipi Kablo Kanalı	60	80	Gri / Grey	16	343,200
8019391088	SWD 80X60 Pano Tipi Kablo Kanalı	80	60	Gri / Grey	20	312,000
8019391098	SWD 80X80 Pano Tipi Kablo Kanalı	80	80	Gri / Grey	16	382,200
8019391108	SWD 80X100 Pano Tipi Kablo Kanalı	80	100	Gri / Grey	8	514,800
8019391118	SWD 100X60 Pano Tipi Kablo Kanalı	100	60	Gri / Grey	12	460,200
8019391128	SWD 100X80 Pano Tipi Kablo Kanalı	100	80	Gri / Grey	8	514,800
8019391138	SWD 100X100 Pano Tipi Kablo Kanalı	100	100	Gri / Grey	8	592,800

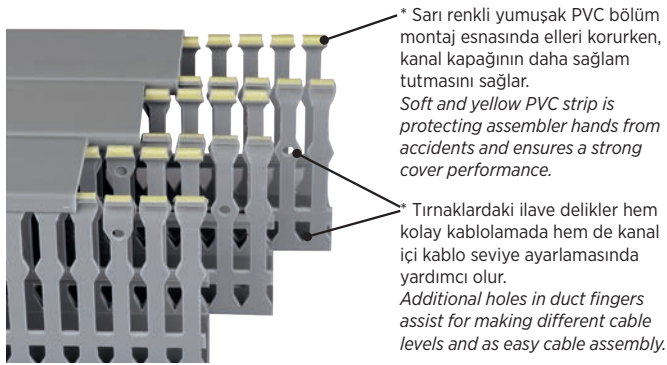

Kablo Kanal Kapakları

Wiring Duct Covers

Ürün Kodu Product Code	Ürün Adı Product Name	En Width (mm.)	Boy Length (m.)	Renk Color	Ambalaj Miktarı Package Qty (metre/meter)	Birim Fiyatı Unit Price (TL/mt.)
8019391208	SWC 25 Kapak	20	2	Gri / Grey	40	42,900
8019391218	SWC 40 Kapak	40	2	Gri / Grey	40	65,650
8019391228	SWC 60 Kapak	60	2	Gri / Grey	40	91,000
8019391238	SWC 80 Kapak	80	2	Gri / Grey	40	128,700
8019391248	SWC 100 Kapak	100	2	Gri / Grey	40	171,600



Teknik Bilgiler

Technical Information

Ürün Kodu Product Code	Ürün Adı Product Name	Ölçüler / Dimensions (mm)						Ölçülmüş Toplam Kesit Measured Total Cross Sec. (mm ²)	İletken Dolum Kapasitesi (%60 oran için) Wire Filling Capacity (for 60% ratio)		
		W	H	E	F	G	Ø		2,5 mm ²	1,5 mm ²	1,0 mm ²
8019391008	SWD 25X40	25	40	6,5	6	12,8	4,5	820	35	51	78
8019391018	SWD 25X60	25	60	6,5	6	15,7	4,5	1.190	57	83	112
8019391028	SWD 40X40	40	40	6,5	6	12,8	4,5	1.360	65	94	129
8019391038	SWD 40X60	40	60	6,5	6	15,7	4,5	2.040	98	141	192
8019391048	SWD 40X80	40	80	6,5	6	19,8	4,5	2.700	130	187	255
8019391058	SWD 60X40	60	40	6,5	6	12,8	4,5	1.970	95	134	188
8019391068	SWD 60X60	60	60	6,5	6	15,7	4,5	3.080	148	214	291
8019391078	SWD 60X80	60	80	6,5	6	19,8	4,5	4.140	200	289	392
8019391088	SWD 80X60	80	60	6,5	6	15,7	4,5	4.150	200	288	391
8019391098	SWD 80X80	80	80	6,5	6	19,8	4,5	5.660	272	393	534
8019391118	SWD 100X60	100	60	6,5	6	15,7	4,5	5.250	254	364	491
8019391128	SWD 100X80	100	80	6,5	6	19,8	4,5	7.606	255	418	702
8019391138	SWD 100X100	100	100	6,5	6	19,8	4,5	8.920	430	619	812

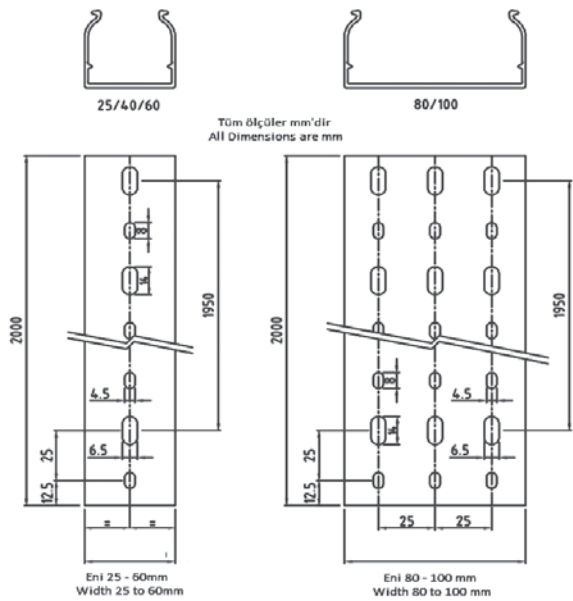
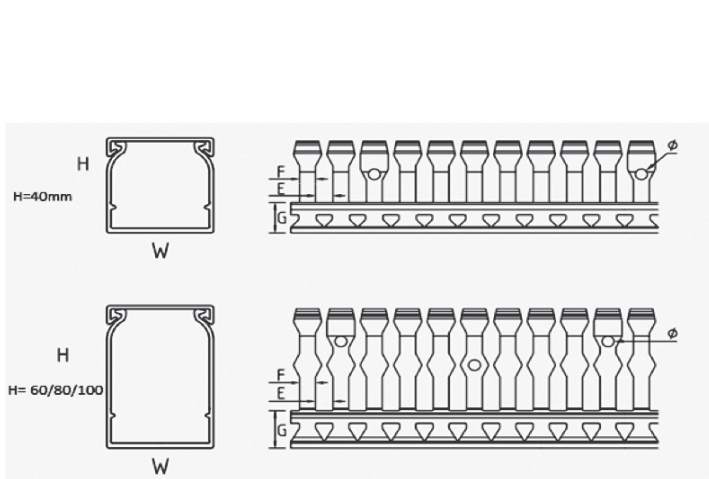

- Kanallar ve kapaklar 2 mt. lik boyda kesilmiş ve paketlenmiştir.
- *Wiring ducts and covers are cut and packed in 2 m length.*



Termal Transfer Yazıcı

Thermal Transfer Printer

Ürün Kodu Product Code	Ürün Adı Product Name	Amb. Mik. Pack. Qty. (Ad./Pcs.)	Birim Fiyatı Unit Price (TL/Adet)
8030129000	TBL TP2 Termal Yazıcı / Thermal Printer	1	Sorunuz



Ribonlar

Ribbons

Ürün Kodu Product Code	Ürün Adı Product Name	İç Çap Inner Diameter (mm)	Ölçüler Dimensions (mmxmm)	Renk Color	Amb. Mik. Pack. Qty. (Ad./Pcs.)	Birim Fiyatı Unit Price (TL/Adet)
8030129120	RR Ribbon 50x300	25,4 (1 inch)	50x300	Siyah / Black	1	4.576,000
8030129130	RR Ribbon 110x300	25,4 (1 inch)	110x300	Siyah / Black	1	10.257,000



Klemensler için Şerit Etiket

Terminal Blocks Strip Label

Ürün Kodu Product Code	Ürün Adı Product Name	Ölçüler Dimensions (mmxmm)	Renk Color	Rulo Etiket Adedi Labels per Roll	Amb. Mik. Pack. Qty. (Ad./Pcs.)	Birim Fiyatı Unit Price (TL/Adet)
8020384009	TBSL 22X20	22x20	Beyaz White	2 adet Şerit Etiket 2 pcs. of Strip Label	1	2.405,000
8020384011	TBSL 5,15x5	25,75x20	Beyaz White	5 adet Şerit Etiket 5 pcs. of Strip Label	1	2.405,000



TBSL 22X20



Kablo İşaretleme Plakaları (Şeffaf Tüpler için)

Cable Marking Plates (for Transparent Sleeves)



TSL 10x4
ön yüz
front side

TSL 10x4
arka yüz
back side

Ürün Kodu Product Code	Ürün Adı Product Name	Yazım Alanı Print Area (mm)	Açıklama Explanation	Amb. Mik. Pack. Qty. (Ad./Pcs.)	Birim Fiyatı Unit Price (TL/Rulo)	Adet Fiyatı Pcs. Price (TL/Ad.)
8021340004	TSL 10x4 Sarı - Beyaz / Yellow - White	10 x 4	Katlamalı Folded	3.000	11.310,000	3,7700
8021340104	TSL 12x4 Sarı - Beyaz / Yellow - White	12 x 4	Katlamalı Folded	3.000	11.960,000	3,9867
8021340014	TSL 15x4 Sarı - Beyaz / Yellow - White	15 x 4	Katlamalı Folded	3.000	12.220,000	4,0733
8021340024	TSL 23x4 Sarı - Beyaz / Yellow - White	23 x 4	Katlamalı Folded	3.000	13.975,000	4,6583
8021340034	TSL 30x4 Sarı - Beyaz / Yellow - White	30 x 4	Katlamalı Folded	3.000	18.330,000	6,1100

Şeffaf Tüpler

Transparent Sleeves - Closed / Insertion Type



TS 10 1,5-2,5



TS 10 2,5-4,0



TS 10 6,0-10



TS 10 16-25

Ürün Kodu Product Code	Ürün Adı Product Name	Uzunluk Length (mm)	Renk Color	İletken Kesit Cond. Cross Sec. (mm ²)	Amb. Mik. Pack. Qty. (Ad./Pcs.)	Birim Fiyatı Unit Price (TL/Kutu)	Adet Fiyatı Pcs. Price (TL/Ad.)
8021343019	TS 10 1,5-2,5	10	Şeffaf / Transparent	1,5 - 2,5	500	1092,000	2,1840
8021343029	TS 12 1,5-2,5	12	Şeffaf / Transparent	1,5 - 2,5	500	1.521,000	3,0420
8021343039	TS 15 1,5-2,5	15	Şeffaf / Transparent	1,5 - 2,5	500	1.521,000	3,0420
8021343049	TS 20 1,5-2,5	20	Şeffaf / Transparent	1,5 - 2,5	500	2.067,000	4,1340
8021343059	TS 30 1,5-2,5	30	Şeffaf / Transparent	1,5 - 2,5	500	4.030,000	8,0600
8021344019	TS 10 2,5-4,0	10	Şeffaf / Transparent	2,5 - 4	500	1.417,000	2,8340
8021344029	TS 12 2,5-4,0	12	Şeffaf / Transparent	2,5 - 4	500	1.742,000	3,4840
8021344039	TS 15 2,5-4,0	15	Şeffaf / Transparent	2,5 - 4	500	1.963,000	3,9260
8021344049	TS 20 2,5-4,0	20	Şeffaf / Transparent	2,5 - 4	500	2.184,000	4,3680
8021344059	TS 30 2,5-4,0	30	Şeffaf / Transparent	2,5 - 4	500	4.238,000	8,4760
8021345019	TS 10 6,0-10	10	Şeffaf / Transparent	6 - 10	500	1.586,000	3,1720
8021345029	TS 12 6,0-10	12	Şeffaf / Transparent	6 - 10	500	1.963,000	3,9260
8021345039	TS 15 6,0-10	15	Şeffaf / Transparent	6 - 10	500	2.067,000	4,1340
8021345049	TS 20 6,0-10	20	Şeffaf / Transparent	6 - 10	500	2.834,000	5,6680
8021345059	TS 30 6,0-10	30	Şeffaf / Transparent	6 - 10	500	4.576,000	9,1520
8021346019	TS 10 16-25	10	Şeffaf / Transparent	16 - 25	500	2.067,000	4,1340
8021346029	TS 12 16-25	12	Şeffaf / Transparent	16 - 25	500	2.509,000	5,0180
8021346039	TS 15 16-25	15	Şeffaf / Transparent	16 - 25	500	2.834,000	5,6680
8021346049	TS 20 16-25	20	Şeffaf / Transparent	16 - 25	200	1.482,000	7,4100
8021346059	TS 30 16-25	30	Şeffaf / Transparent	16 - 25	200	2.444,000	12,2200

İnce Yapışkanlı Etiketler (Pano Yüzeyi, Kontaktör ve Pano İçi Diğer Cihazlar için)

Slim Adhesive Labels (For Panel Surface, Contactors and Other Devices Inside Panel)

Ürün Kodu Product Code	Ürün Adı Product Name	Yazım Alanı Print Area (mm)	Renk Color	Amb. Mik. Pack. Qty. (Ad./Pcs.)	Birim Fiyatı Unit Price (TL/Rulo)	Adet Fiyatı Pcs. Price (TL/Ad.)
8022120004	SPEL 12x9	12x9	Sarı / Yellow	2.500	2.314,000	0,9256
8022120008	SPEL 12x9	12x9	Gümüş / Silver	2.500	2.314,000	0,9256
8022120009	SPEL 12x9	12x9	Beyaz / White	2.500	2.314,000	0,9256
8022120014	SPEL 15x6	15x6	Sarı / Yellow	2.500	2.392,000	0,9568
8022120018	SPEL 15x6	15x6	Gümüş / Silver	2.500	2.392,000	0,9568
8022120019	SPEL 15x6	15x6	Beyaz / White	2.500	2.392,000	0,9568
8022120024	SPEL 15x9	15x9	Sarı / Yellow	2.500	3.601,000	1,4404
8022120028	SPEL 15x9	15x9	Gümüş / Silver	2.500	3.601,000	1,4404
8022120029	SPEL 15x9	15x9	Beyaz / White	2.500	3.601,000	1,4404
8022120034	SPEL 17x10	17x10	Sarı / Yellow	2.500	3.601,000	1,4404
8022120038	SPEL 17x10	17x10	Gümüş / Silver	2.500	3.601,000	1,4404
8022120039	SPEL 17x10	17x10	Beyaz / White	2.500	3.601,000	1,4404
8022120044	SPEL 18x8	18x8	Sarı / Yellow	2.500	3.705,000	1,4820
8022120048	SPEL 18x8	18x8	Gümüş / Silver	2.500	3.705,000	1,4820
8022120049	SPEL 18x8	18x8	Beyaz / White	2.500	3.705,000	1,4820
8022120054	SPEL 27x12,5	27x12	Sarı / Yellow	2.500	7.423,000	2,9692
8022120058	SPEL 27x12,5	27x12	Gümüş / Silver	2.500	7.423,000	2,9692
8022120059	SPEL 27x12,5	27x12	Beyaz / White	2.500	7.423,000	2,9692
8022120064	SPEL 27x15	27x15	Sarı / Yellow	2.500	7.852,000	3,1408
8022120068	SPEL 27x15	27x15	Gümüş / Silver	2.500	7.852,000	3,1408
8022120069	SPEL 27x15	27x15	Beyaz / White	2.500	7.852,000	3,1408
8022120074	SPEL 27x18	27x18	Sarı / Yellow	2.500	8.515,000	3,4060
8022120078	SPEL 27x18	27x18	Gümüş / Silver	2.500	8.515,000	3,4060
8022120079	SPEL 27x18	27x18	Beyaz / White	2.500	8.515,000	3,4060
8022120098	SPEL 35x18	35x18	Gümüş / Silver	1.500	5.889,000	3,9260
8022120108	SPEL 45x15	45x15	Gümüş / Silver	2.000	8.073,000	4,0365
8022120118	SPEL 70x30	70x30	Gümüş / Silver	250	4.447,000	16,5880
8022120128	SPEL 90x40	90x40	Gümüş / Silver	250	4.537,000	18,1480
8022120138	SPEL 100x50	100x50	Gümüş / Silver	250	4.849,000	19,3960

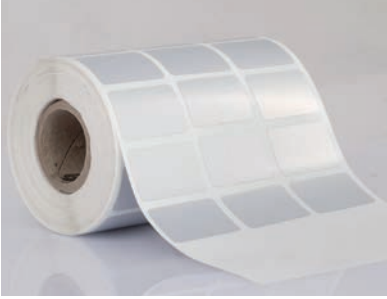

SPEL 27x15



SPEL 35x15



SPEL 15x6

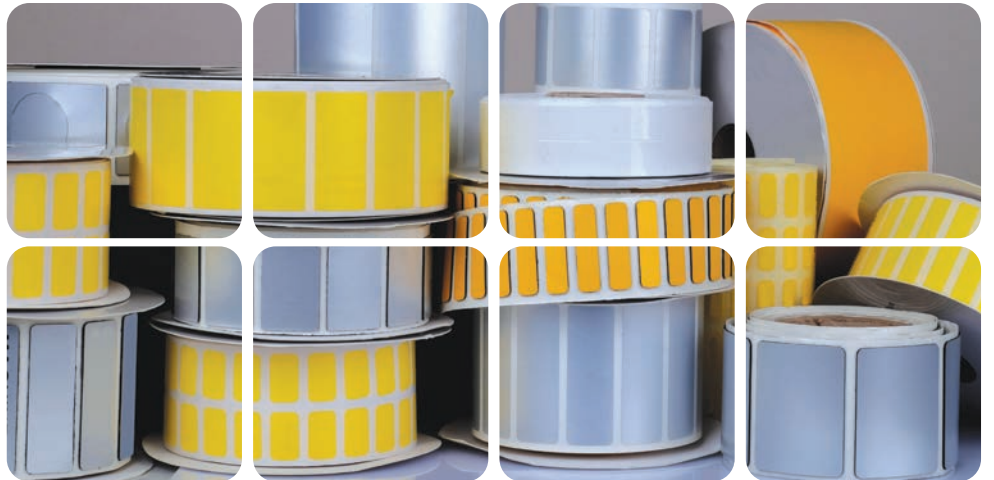

Kalın Yapışkanlı Etiketler (Pano Yüzeyi için)

Thick Adhesive Labels (For Panel Surface)



TPEL 40x30



TPEL 60x15



TPEL 45x15

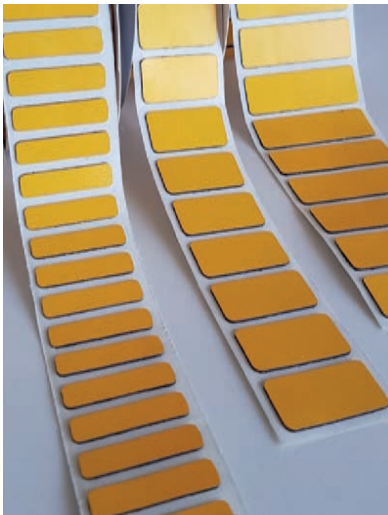

Ürün Kodu Product Code	Ürün Adı Product Name	Yazım Alanı Print Area (mm)	Renk Color	Amb. Mik. Pack. Qty. (Ad./Pcs.)	Birim Fiyatı Unit Price (TL/Rulo)	Adet Fiyatı Pcs. Price (TL/Ad.)
8022130014	TPEL 22x22	22x22	Sarı / Yellow	150	5.668,000	37,7867
8022130018	TPEL 22x22	22x22	Gümüş / Silver	150	5.668,000	37,7867
8022130019	TPEL 22x22	22x22	Beyaz / White	150	5.668,000	37,7867
8022130004	TPEL 27x12,5	27x12	Sarı / Yellow	150	4.030,000	26,8667
8022130008	TPEL 27x12,5	27x12	Gümüş / Silver	150	4.030,000	26,8667
8022130009	TPEL 27x12,5	27x12	Beyaz / White	150	4.030,000	26,8667
8022130024	TPEL 27x15	27x15	Sarı / Yellow	150	4.693,000	31,2867
8022130028	TPEL 27x15	27x15	Gümüş / Silver	150	4.693,000	31,2867
8022130029	TPEL 27x15	27x15	Beyaz / White	150	4.693,000	31,2867
8022130109	TPEL 27x18	27x18	Beyaz / White	150	4.693,000	31,2867
8022130108	TPEL 27x18	27x18	Gümüş / Silver	150	4.693,000	31,2867
8022130104	TPEL 27x18	27x18	Sarı / Yellow	150	4.693,000	31,2867
8022130034	TPEL 27x27	27x27	Sarı / Yellow	150	6.552,000	43,6800
8022130038	TPEL 27x27	27x27	Gümüş / Silver	150	6.552,000	43,6800
8022130039	TPEL 27x27	27x27	Beyaz / White	150	6.552,000	43,6800
8022130044	TPEL 35x18	35x18	Sarı / Yellow	150	6.981,000	46,5400
8022130048	TPEL 35x18	35x18	Gümüş / Silver	150	6.981,000	46,5400
8022130049	TPEL 35x18	35x18	Beyaz / White	150	6.981,000	46,5400
8022130054	TPEL 40x30	40x30	Sarı / Yellow	125	9.607,000	76,8560
8022130058	TPEL 40x30	40x30	Gümüş / Silver	125	9.607,000	76,8560
8022130059	TPEL 40x30	40x30	Beyaz / White	125	9.607,000	76,8560
8022130064	TPEL 45x15	45x15	Sarı / Yellow	150	8.944,000	59,6267
8022130068	TPEL 45x15	45x15	Gümüş / Silver	150	8.944,000	59,6267
8022130069	TPEL 45x15	45x15	Beyaz / White	150	8.944,000	59,6267
8022130074	TPEL 60x15	60x15	Sarı / Yellow	150	10.920,000	72,8000
8022130078	TPEL 60x15	60x15	Gümüş / Silver	150	10.920,000	72,8000
8022130079	TPEL 60x15	60x15	Beyaz / White	150	10.920,000	72,8000
8022130084	TPEL 60x30	60x30	Sarı / Yellow	125	12.220,000	97,7600
8022130088	TPEL 60x30	60x30	Gümüş / Silver	125	12.220,000	97,7600
8022130089	TPEL 60x30	60x30	Beyaz / White	125	12.220,000	97,7600
8022130094	TPEL 90x45	90x45	Sarı / Yellow	50	7.644,000	152,8800
8022130098	TPEL 90x45	90x45	Gümüş / Silver	50	7.644,000	152,8800
8022130099	TPEL 90x45	90x45	Beyaz / White	50	7.644,000	152,8800



Buton Etiketleri (22 mm Çapa Uygun)

Push Button Labels (Suitable for 22 mm Diameter)



TPBL 30x40

Ürün Kodu Product Code	Ürün Adı Product Name	Yazım Alanı Print Area (mm)	Renk Color	Delik Çapı Hole Dia. (mm)	Amb. Mik. Pack. Qty. (Ad./Pcs.)	Birim Fiyatı Unit Price (TL/Rulo)	Adet Fiyatı Pcs. Price (TL/Ad.)
8022130114	TPBL 30x40	30 x 13	Sarı / Yellow	23,5	100	6.214,00	62,1400
8022130118	TPBL 30x40	30 x 13	Gümüş / Silver	23,5	100	6.214,00	62,1400
8022130119	TPBL 30x40	30 x 13	Beyaz / White	23,5	100	6.214,00	62,1400



TPBL 30x40

Buton Etiket Tutucular (22 mm Çapa Uygun)

Push Button Labels (Suitable for 22 mm Diameter)



TBET 50X30 TBET 40X30

Ürün Kodu Product Code	Ürün Adı Product Name	Yazım Alanı Print Area (mm)	Renk Color	Amb. Mik. Pack. Qty. (Ad./Pcs.)	Birim Fiyatı Unit Price (TL/Amb.)	Adet Fiyatı Pcs. Price (TL/Ad.)
8022130330	TBET 40X30	25 x 8	Siyah / Black	60	1.365,000	22,750
8022130340	TBET 50X30	25 x 18	Siyah / Black	60	1.391,000	23,183

Yapışkanlı Pano Etiket Tutucular

Self Adhesive Panel Labels Holders



TYPET 17x75



TYPET 17x50



TYPET 17x30

Ürün Kodu Product Code	Ürün Adı Product Name	Yazım Alanı Print Area (mm)	Renk Color	Amb. Mik. Pack. Qty. (Ad./Pcs.)	Birim Fiyatı Unit Price (TL/Amb.)	Adet Fiyatı Pcs. Price (TL/Ad.)
8022130300	TYPET 17x30	27 x 14	Siyah / Black	100	1.781,000	17,810
8022130310	TYPET 17x50	49 x 15	Siyah / Black	50	1040,000	20,800
8022130320	TYPET 17x75	72 x 15	Siyah / Black	25	598,000	23,920

Boş yazım kağıtları paketin içerisinde.

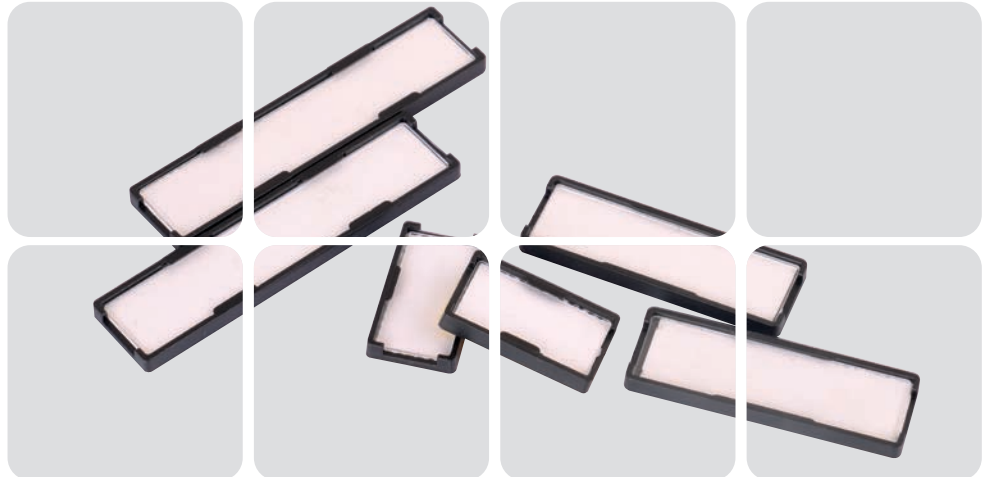

Klemens Grup Etiketleri için Etiketler

Labels for Terminal Blocks Group Markers

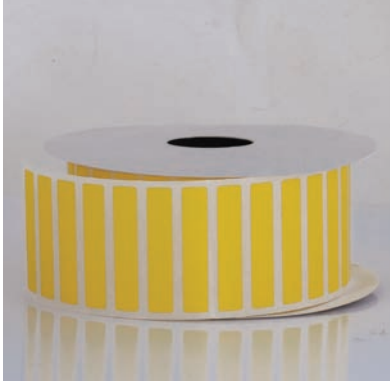

GML 2 36x7

Ürün Kodu Product Code	Ürün Adı Product Name	Yazım Alanı Print Area (mm)	Renk Color	Uyumlu Ürün Explanation	Amb. Mik. Pack. Qty. (Ad./Pcs.)	Birim Fiyatı Unit Price (TL/Rulo)	Adet Fiyatı Pcs. Price (TL/Ad.)
8022130124	GML 1 36x17	36 x 17	Sarı / Yellow	GM 1	2.000	6.760,000	3,380
8022130134	GML 2 36x7	36 x 7	Sarı / Yellow	GM 2	2.000	5.890,000	2,945



Yapışkanlı Bant Etiketler

Self Adhesive Endless Labels



SALT 5x20

Ürün Kodu Product Code	Ürün Adı Product Name	Ölçüler Dimensions (mmxm)	Renk Color	Amb. Mik. Pack. Qty. (Ad./Pcs.)	Birim Fiyatı Unit Price (TL/Rulo)
8022130144	SALT 5x20	50 x 20	Sarı / Yellow	1	3.640,000
8022130128	SALT 5x20	50 x 20	Gümüş / Silver	1	3.640,000
8022130129	SALT 5x20	50 x 20	Beyaz / White	1	3.640,000

Acil Stop Etiketleri (22mm Çapa Uygun)

Emergency Stop Labels (Suitable for 22mm Diameter)



Ürün Kodu Product Code	Ürün Adı Product Name	Etiket Çapı Label Dia. (mm)	Delik Çapı Hole Dia. (mm)	Renk Color	Amb. Mik. Pack. Qty. (Ad./Pcs.)	Birim Fiyatı Unit Price (TL/Adet)
8022130350	ASE60	60	23,5	Sarı / Yellow	1	97,500



RCTL 50x15



HCTL 25x10

Kablo Bağı ile Bağlanan Etiketler (Doğrudan Kablo Bağına Takılan)

Labels Assembled with Cable Ties (Directly Assembled to Cable Ties)

Ürün Kodu Product Code	Ürün Adı Product Name	Yazım Alanı Print Area (mm)	Renk Color	Açıklama Explanation	Amb. Mik. Pack. Qty. (Ad./Pcs.)	Birim Fiyatı Unit Price (TL/Rulo)	Adet Fiyatı Pcs. Price (TL/Ad.)
8021341019	HCTL 25x10	25 x 10	Beyaz / White	Altıgen / Hexagonal	250	7.930,000	31,720
8021342019	RCTL 25x10	25 x 10	Beyaz / White	Dikdörtgen / Rectangular	250	7.930,000	31,720
8021342029	RCTL 50x15	50 x 15	Beyaz / White	Dikdörtgen / Rectangular	250	13.325,000	53,300
8021342039	RCTL 60x30	60 x 30	Beyaz / White	Dikdörtgen / Rectangular	250	14.430,000	57,720



CM 1

Kablo Bağı ile Bağlanan Etiketler (Etiket Kılıfıyla Bağlananlar)

Labels Assembled with Cable Ties (Assembled with Label Holder)

Ürün Kodu Product Code	Ürün Adı Product Name	Yazım Alanı Print Area (mm)	Renk Color	Açıklama Explanation	Amb. Mik. Pack. Qty. (Ad./Pcs.)	Birim Fiyatı Unit Price (TL/Amb.)	Adet Fiyatı Pcs. Price (TL/Ad.)
8021334009	CM 1		Beyaz / White	Etiket Kılıfı 1 Label Holder 1	100	676,000	6,760
8021334019	CM 2		Beyaz / White	Etiket Kılıfı 2 Label Holder 2	100	988,000	9,880

Boş yazım kağıtları paketin içerisinde.

Ürün Kodu Product Code	Ürün Adı Product Name	Renk Color	Ölçüler Dimensions		
			L	W	T
8021334009	CM 1	Beyaz / White	35	10	8
8021334019	CM 2	Beyaz / White	45	20	8

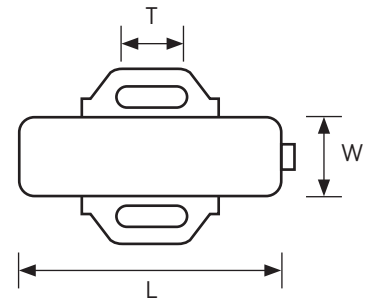

CM 1

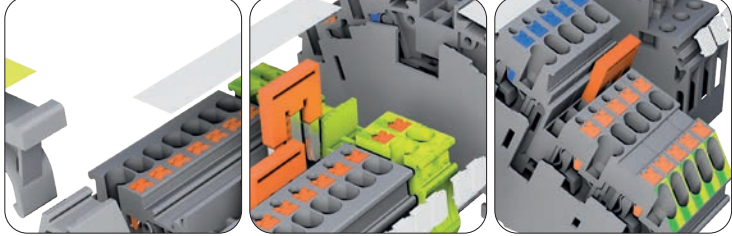
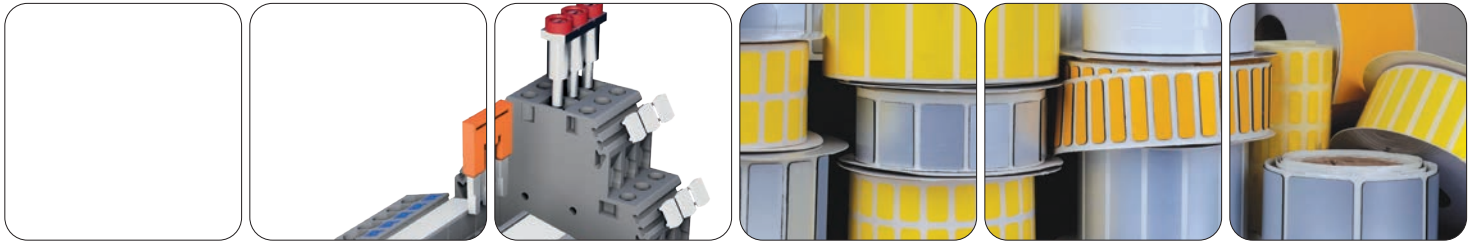

t bloc

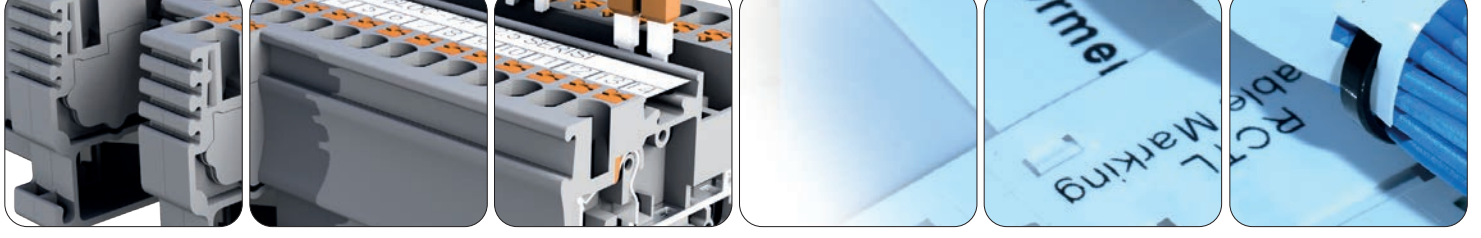
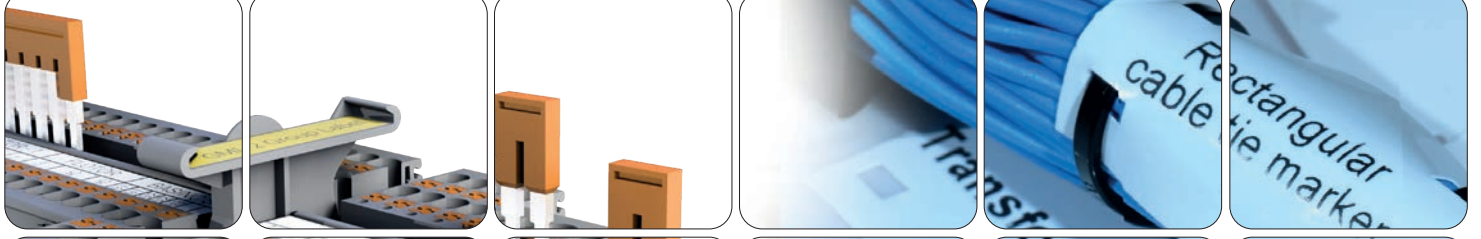
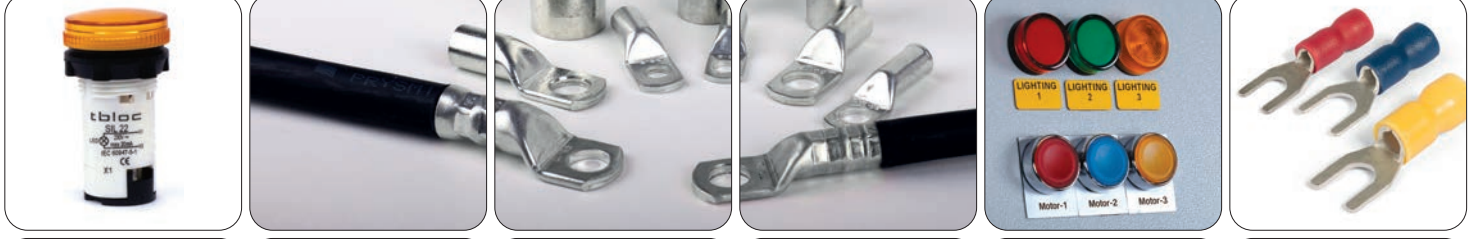



Plastik Kablo Bağları

Plastic Cable Ties

Ürün Kodu Product Code	Ürün Adı Product Name	Ölçüler (BoyxEn) Dimensions (LxW) (mm)	Maks. Sıkma Çapı Max. Bundle Dia. (mm)	Min. Açılma Mukavemeti Min. Loop Tensile Strenght (kg.)	Amb. Mik. Pack. Qty (Adet/Pcs.)	Koli Mik. Carton Qty. (Adet/Pcs.)	Birim Fiyatı Unit Price (TL/100 Ad.)
8016330109	PCT 100 x 2.5 Beyaz / White	100 x 2.5	22	8	100	26.000	45,500
8016330110	PCT 100 x 2.5 Siyah / Black	100 x 2.5	22	8	100	26.000	45,500
8016330209	PCT 150 x 2.5 Beyaz / White	150 x 2.5	35	8	100	20.000	66,300
8016330210	PCT 150 x 2.5 Siyah / Black	150 x 2.5	35	8	100	20.000	66,300
8016330309	PCT 200 x 2.5 Beyaz / White	200 x 2.5	55	8	100	18.000	97,500
8016330310	PCT 200 x 2.5 Siyah / Black	200 x 2.5	55	8	100	18.000	97,500
8016330409	PCT 140 x 3.6 Beyaz / White	140 x 3.6	36	18	100	12.000	106,600
8016330410	PCT 140 x 3.6 Siyah / Black	140 x 3.6	36	18	100	12.000	106,600
8016330509	PCT 200 x 3.6 Beyaz / White	200 x 3.6	52	18	100	10.000	159,900
8016330510	PCT 200 x 3.6 Siyah / Black	200 x 3.6	52	18	100	10.000	159,900
8016330609	PCT 250 x 3.6 Beyaz / White	250 x 3.6	68	18	100	8.000	195,000
8016330610	PCT 250 x 3.6 Siyah / Black	250 x 3.6	68	18	100	8.000	195,000
8016330709	PCT 280 x 3.6 Beyaz / White	280 x 3.6	82	18	100	8.000	234,000
8016330710	PCT 280 x 3.6 Siyah / Black	280 x 3.6	82	18	100	8.000	234,000
8016330809	PCT 370 x 3.6 Beyaz / White	370 x 3.6	105	18	100	6.000	299,000
8016330810	PCT 370 x 3.6 Siyah / Black	370 x 3.6	105	18	100	6.000	299,000
8016331009	PCT 200 x 4.8 Beyaz / White	200 x 4.8	49	22	100	7.000	223,600
8016331010	PCT 200 x 4.8 Siyah / Black	200 x 4.8	49	22	100	7.000	223,600
8016331209	PCT 250 x 4.8 Beyaz / White	250 x 4.8	68	22	100	6.000	273,000
8016331210	PCT 250 x 4.8 Siyah / Black	250 x 4.8	68	22	100	6.000	273,000
8016331309	PCT 300 x 4.8 Beyaz / White	300 x 4.8	83	22	100	5.000	325,000
8016331310	PCT 300 x 4.8 Siyah / Black	300 x 4.8	83	22	100	5.000	325,000
8016331509	PCT 370 x 4.8 Beyaz / White	370 x 4.8	105	22	100	4.000	390,000
8016331510	PCT 370 x 4.8 Siyah / Black	370 x 4.8	105	22	100	4.000	390,000
8016331709	PCT 430 x 4.8 Beyaz / White	430 x 4.8	125	22	100	3.000	481,000
8016331710	PCT 430 x 4.8 Siyah / Black	430 x 4.8	125	22	100	3.000	481,000
8016332009	PCT 300 x 7.6 Beyaz / White	300 x 7.6	80	55	100	3.000	650,000
8016332010	PCT 300 x 7.6 Siyah / Black	300 x 7.6	80	55	100	3.000	650,000
8016332209	PCT 370 x 7.6 Beyaz / White	370 x 7.6	101	55	100	2.500	767,000
8016332210	PCT 370 x 7.6 Siyah / Black	370 x 7.6	101	55	100	2.500	767,000
8016332309	PCT 450 x 7.6 Beyaz / White	450 x 7.6	128	55	100	2.500	897,000
8016332310	PCT 450 x 7.6 Siyah / Black	450 x 7.6	128	55	100	2.500	897,000
8016332329	PCT 550 x 7.6 Beyaz / White	550 x 7.6	155	55	100	1.500	1.189,500
8016332320	PCT 550 x 7.6 Siyah / Black	550 x 7.6	155	55	100	1.500	1.189,500
8016332339	PCT 750 x 7.6 Beyaz / White	750 x 7.6	220	55	100	1.200	1.657,500
8016332330	PCT 750 x 7.6 Siyah / Black	750 x 7.6	220	55	100	1.200	1.657,500
8016332409	PCT 600 x 9.0 Beyaz / White	600 x 9.0	160	80	100	1.200	1.827,800
8016332410	PCT 600 x 9.0 Siyah / Black	600 x 9.0	160	80	100	1.200	1.827,800
8016332609	PCT 760 x 9.0 Beyaz / White	760 x 9.0	227	80	100	1.200	2.210,000
8016332610	PCT 760 x 9.0 Siyah / Black	760 x 9.0	227	80	100	1.200	2.210,000
8016332709	PCT 900 x 9.0 Beyaz / White	900 x 9.0	275	80	100	1.200	2.615,600
8016332710	PCT 900 x 9.0 Siyah / Black	900 x 9.0	275	80	100	1.200	2.615,600

- Siyah renkli kablo bağları UV (Ultraviyole) ışınlarına karşı dayanımlıdır.
- Black colored cable ties are UV (Ultraviolet) resistant.



Paslanmaz elik Kablo Bařları - 304 Kalite

Stainless Steel Cable Ties - Grade 304

Ürün Kodu Product Code	Ürün Adı Product Name	Ölçüler (BoyxEen) Dimensions (LxW) (mm)	Maks. Sıkma Çapı Max. Bundle Dia. (mm)	Min. Açılma Mukavemeti Min. Loop Tensile Strenght (kg.)	Amb. Mik. Pack. Qty (Adet/Pcs.)	Koli Mik. Carton Qty. (Adet/Pcs.)	Birim Fiyatı Unit Price (TL/Ad.)
8016335010	SSCT 150x4.6	150x4.6	33	55	100	8.000	9,490
8016335020	SSCT 200x4.6	200x4.6	50	55	100	6.000	10,530
8016335030	SSCT 250x4.6	250x4.6	67	55	100	5.000	11,830
8016335040	SSCT 300x4.6	300x4.6	75	55	100	5.000	12,480
8016335050	SSCT 370x4.6	370x4.6	102	55	100	4.000	13,650
8016335060	SSCT 450x4.6	450x4.6	130	55	100	3.000	15,210
8016335070	SSCT 520x4.6	520x4.6	152	55	100	3.000	17,160
8016335080	SSCT 680x4.6	680x4.6	203	55	100	2.000	21,060
8016335090	SSCT 840x4.6	840x4.6	254	55	100	1.000	25,480
8016335100	SSCT 200x7.9	200x7.9	50	120	100	5.000	15,080
8016335110	SSCT 300x7.9	300x7.9	75	120	100	4.000	16,900
8016335120	SSCT 370x7.9	370x7.9	102	120	100	3.000	18,980
8016335130	SSCT 450x7.9	450x7.9	130	120	100	3.000	22,880
8016335140	SSCT 520x7.9	520x7.9	152	120	100	2.000	25,480
8016335150	SSCT 680x7.9	680x7.9	203	120	100	2.000	32,240
8016335160	SSCT 840x7.9	840x7.9	254	120	100	1.000	36,010
8016335170	SSCT 1000x7.9	1000x7.9	305	120	100	1.000	48,100



Teknik Özellikler

Technical Futures

Malzeme / Material	304 kalite Paslanmaz elik / 304 grade Stainless Steel
Su Emilimi / Water Absorption	Yok / No
Alev Yürümeme / Flame Retardant	UL94V-2
UV Dayanıklılığı / UV Resistance	Mükemmel / Excellent
Kimyasal Dayanım / Chemical Resistance	Mükemmel / Excellent
Çalışma Sıcaklığı / Operating Temperature	-80°C + 538°C

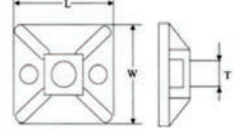

Yapışkan Krořeler

Self Adhesive Tie Mounts

Ürün Kodu Product Code	Ürün Adı Product Name	Ölçüler Dimensions (mm)			Amb. Mik. Pack. Qty (Adet/Pcs.)	Birim Fiyatı Unit Price (TL/100 Adet)
		L	W	T		
8016333009	ATM 19 x 19 Beyaz / White	19	19	3,6	100	220,000
8016333010	ATM 19 x 19 Siyah / Black	19	19	3,6	100	220,000
8016333109	ATM 28 x 28 Beyaz / White	28	28	4,8	100	370,000
8016333110	ATM 28 x 28 Siyah / Black	28	28	4,8	100	370,000



Vidalı Krořeler

Screw Type Tie Mounts

Ürün Kodu Product Code	Ürün Adı Product Name	Ölçüler Dimensions					Amb. Mik. Pack. Qty (Adet/Pcs.)	Birim Fiyatı Unit Price (TL/100 Adet)
		L	W	H	T	B		
8016334009	STM 1 Beyaz / White	17,8	12,7	8,15	4,8	M3	250	1,599
8016334019	STM 2 Beyaz / White	25,4	16	10,8	9	M5	250	2,145
8016334010	STM 1 Siyah / Black	17,8	12,7	8,15	4,8	M3	250	1,599
8016334020	STM 2 Siyah / Black	25,4	16	10,8	9	M5	250	2,145



Kablo Bağı Aleti

Cable Tie Tool

Ürün Kodu Product Code	Ürün Adı Product Name	Özellik Function	Maks. Kablo Bağı Eni Max. Cable Tie Width (mm)	Amb. Mik. Pack. Qty (Adet/Pcs.)	Birim Fiyatı Unit Price (TL/Adet)
8016334200	CTT1	Sıkma + Kesme Tightening + Cutting	4,8	1	1.560,000

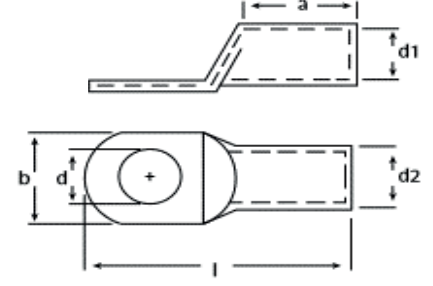

Eko Seri Sıkmalı Kablo Pabuçları

Economical Compression Cable Lugs

Ürün Kodu Product Code	Ürün Adı Product Name	Kesit Cross Sec. (mm ²)	Ölçüler / Dimensions (mm)						Delik Çapı Hole Dia.	Amb. Mik. Pack. Qty. (Adet/Pcs.)	Birim Fiyatı Unit Price (TL/Adet)
			d	d1	d2	l	a	b			
8029320500	CCL-E 16 mm² M6	16	6,5	5,5	7	32,5	11	10,5	M6	500	15,860
8029320510	CCL-E 16 mm² M8	16	8,5	5,5	7	32,5	11	13	M8	500	17,940
8029320520	CCL-E 25 mm² M8	25	8,5	7	9	38,5	16	13	M8	300	23,790
8029320530	CCL-E 35 mm² M8	35	8,5	8,5	10,5	43,5	19	15,5	M8	200	31,200
8029320540	CCL-E 50 mm² M10	50	10,5	10	12	51,5	21	17,6	M10	125	49,400
8029320550	CCL-E 70 mm² M10	70	10,5	11,5	14	55,5	23	20,7	M10	100	76,700
8029320560	CCL-E 95 mm² M12	95	13	13,5	16	58,5	26	23,5	M12	75	92,300
8029320570	CCL-E 120 mm² M12	120	13	15,5	18	71	29	26,7	M12	50	136,500
8029320580	CCL-E 150 mm² M12	150	13	16,5	20	76	30	29,2	M12	30	214,500
8029320590	CCL-E 185 mm² M16	185	17	18,5	22	82	33	32,3	M16	25	243,100
8029320600	CCL-E 240 mm² M16	240	17	21,5	25,5	91	38	37,6	M16	20	374,400

Malzeme : EN 13600 Standardında elektrolitik bakır
Kaplama : Minimum 3 mikron (µm) Kalay Kaplama

Material : EN 13600 Standarts Electrolytically Tin (E-Cu) Plated Copper
Plating : Minimum 3 microns (µm) Tin Plated



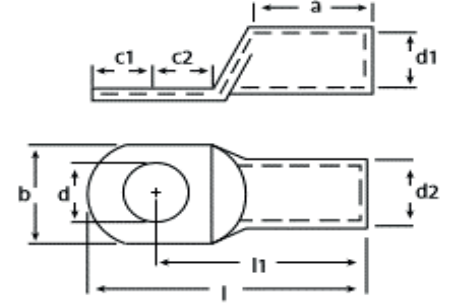

Standart Seri Sıkmalı Kablo Pabuçları

Standart Range Compression Lugs

Ürün Kodu Product Code	Ürün Adı Product Name	Kesit Cross Sec. (mm ²)	Ölçüler / Dimensions (mm)										Delik Çapı Hole Dia.	Amb. Mik. Pack. Qty. (Adet/Pcs.)	Birim Fiyatı Unit Price (TL/Adet)
			d	d1	d2	l	l1	a	b	c1	c2				
8029320610	CCL 10mm ² M6	10	6,5	4,4	6	27,5	21,7	10	10,4	6	6	M6	500	14,430	
8029320620	CCL 10mm ² M8	10	8,5	4,4	6	27,5	21,7	10	13,7	6	6	M8	500	14,950	
8029320630	CCL 16mm ² M6	16	6,5	5,5	8	32,6	24,9	12	11,4	7	8	M6	300	26,650	
8029320640	CCL 16mm ² M8	16	8,5	5,5	8	32,6	24,9	12	13,9	7	8	M8	300	24,830	
8029320641	CCL 16mm ² M10	16	10,5	5,5	8	32,6	24,9	12	16,1	7	8	M10	300	25,350	
8029320649	CCL 25mm ² M6	25	6,5	6,8	9	39	32,3	16	13,6	6,8	9,2	M6	200	40,690	
8029320650	CCL 25mm ² M8	25	8,5	6,8	9	39	32,3	16	13,7	6,8	9,2	M8	200	39,780	
8029320651	CCL 25mm ² M10	25	10,5	7	9,5	42	34,1	16	16,1	6,8	11	M10	200	39,000	
8029320659	CCL 35mm ² M6	35	6,5	8,2	11	44	35,6	19	15,9	8,3	9,7	M6	150	53,950	
8029320660	CCL 35mm ² M8	35	8,5	8,2	11	44	35,6	19	15,9	8,3	9,7	M8	150	53,950	
8029320661	CCL 35mm ² M10	35	10,5	8,2	11	48	37,9	19	15,8	10	12	M10	150	52,000	
8029320669	CCL 50mm ² M8	50	8,5	9,5	12	47,5	39,3	21	17,8	8,3	9,7	M8	100	87,360	
8029320670	CCL 50mm ² M10	50	10,5	9,5	12	51,5	41,6	21	17,9	10	12	M10	100	89,700	
8029320671	CCL 50mm ² M12	50	13	10,1	13	51,5	41,6	21	19,2	10	12	M12	100	89,700	
8029320672	CCL 50mm ² M14	50	15	10,1	13	56,5	44,6	21	20,7	12	15	M14	100	107,120	
8029320679	CCL 70mm ² M8	70	8,5	11,2	14,5	54,6	44,5	23	21,2	10	12	M8	75	127,400	
8029320680	CCL 70mm ² M10	70	10,5	11,2	14,5	54,6	44,5	23	21,2	10	12	M10	75	120,900	
8029320681	CCL 70mm ² M12	70	13	11,2	14,5	54,6	44,5	23	21,3	10	12	M12	75	115,700	
8029320682	CCL 70mm ² M14	70	15	11,2	14,5	62,6	47,5	23	21,5	15	15	M14	75	145,600	
8029320689	CCL 95mm ² M8	95	8,5	13,4	17	58,8	48,9	26	24,7	10	12	M8	50	154,050	
8029320690	CCL 95mm ² M10	95	10,5	13,4	17	58,8	48,9	26	24,7	10	12	M10	50	150,800	
8029320700	CCL 95mm ² M12	95	13	13,4	17	58,8	48,9	26	24,6	10	12	M12	50	146,250	
8029320709	CCL 120mm ² M10	120	10,5	15,5	19	69	55,9	29	28,1	13	14,5	M10	40	226,200	
8029320710	CCL 120mm ² M12	120	13	15,5	19	69	55,9	29	28,2	13	14,5	M12	40	204,750	
8029320711	CCL 120mm ² M16	120	17	15,5	19	69	55,9	29	28,2	13	14,5	M16	40	204,750	
8029320719	CCL 150mm ² M10	150	10,5	16,5	16,5	76,5	59,9	30	30,2	16,5	16,5	M10	30	318,500	
8029320720	CCL 150mm ² M12	150	13	16,5	21	76,5	59,9	30	30,1	16,5	16,5	M12	30	314,600	
8029320721	CCL 150mm ² M16	150	17	16,5	21	76,5	59,9	30	30,1	16,5	16,5	M16	30	312,000	
8029320729	CCL 185mm ² M12	185	13	18,5	23	82,5	65,6	33	34,2	17	18	M12	25	370,500	
8029320730	CCL 185mm ² M16	185	17	18,5	23	82,5	65,6	33	34,1	17	18	M16	25	353,600	
8029320739	CCL 240mm ² M12	240	13	21	26	89	72,1	38	38,2	17	18	M12	20	500,500	
8029320740	CCL 240mm ² M16	240	17	21	26	89	72,1	38	38,2	17	18	M16	20	494,000	

Malzeme : EN 13600 Standardında elektrolitik bakır
Kaplama : Minimum 3 mikron (µm) Kalay Kaplama

Material : EN 13600 Standarts Electrolytically Tin (E-Cu) Plated Copper
Plating : Minimum 3 microns (µm) Tin Plated

** Koyu renk ile işaretlenmiş kablo pabuçları standart ürünlerimiz olup, diğer kalemler için lütfen stok durumunu sorunuz.

** Bold colored Lugs items are our standart sizes, pls advise for other items stocks availability



Eko Seri Ek Muflar

Economical Range Compression Butt Terminals

Ürün Kodu Product Code	Ürün Adı Product Name	Kesit Cross Sec. (mm ²)	Uzunluk Length (l) mm	Amb. Mik. Pack. Qty. (Adet/Pcs.)	Birim Fiyatı Unit Price (TL/Adet)
8029320750	CBT-E 16 mm ²	16	32	300	17,290
8029320760	CBT-E 25 mm ²	25	41	200	28,210
8029320770	CBT-E 35 mm ²	35	46	150	36,790
8029320780	CBT-E 50 mm ²	50	54	125	52,000
8029320790	CBT-E 70 mm ²	70	58	100	82,420
8029320800	CBT-E 95 mm ²	95	62	60	98,410
8029320810	CBT-E 120 mm ²	120	74	40	141,960
8029320820	CBT-E 150 mm ²	150	80	30	224,250
8029320830	CBT-E 185 mm ²	185	86	22	260,520
8029320840	CBT-E 240 mm ²	240	95	15	376,350

Malzeme : EN 13600 Standardında elektrolitik bakır
Kaplama : Minimum 3 mikron (µm) Kalay Kaplama

Material : EN 13600 Standarts Electrolytically Tin (E-Cu) Plated Copper
Plating : Minimum 3 microns (µm) Tin Plated

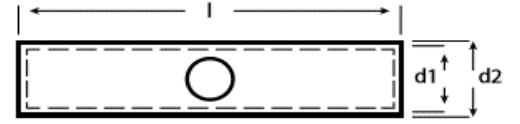

Standart Seri Ek Muflar

Standard Range Compression Butt Terminals

Ürün Kodu Product Code	Ürün Adı Product Name	Kesit Cross Sec. (mm ²)	Ölçüler / Dimensions (mm)			Amb. Mik. Pack. Qty. (Adet/Pcs.)	Birim Fiyatı Unit Price (TL/Adet)
			d1	d2	l		
8029320845	CBT 10 mm ²	10	4,4	6	27	400	17,290
8029320850	CBT 16 mm ²	16	5,5	8	32	250	29,380
8029320860	CBT 25 mm ²	25	7	9	40,5	200	43,550
8029320870	CBT 35 mm ²	35	8,2	11	45,5	150	78,000
8029320880	CBT 50 mm ²	50	9,5	13	53,5	80	104,000
8029320890	CBT 70 mm ²	70	11,2	14,5	57,5	60	146,900
8029320900	CBT 95 mm ²	95	13,4	17	61,5	40	189,800
8029320910	CBT 120 mm ²	120	15	19,5	74	30	260,000
8029320920	CBT 150 mm ²	150	16,5	21	79	25	405,600
8029320930	CBT 185 mm ²	185	19	24	85	18	442,000
8029320940	CBT 240 mm ²	240	21	26	95	13	585,000

Malzeme : EN 13600 Standardında elektrolitik bakır
Kaplama : Minimum 3 mikron (µm) Kalay Kaplama

Material : EN 13600 Standarts Electrolytically Tin (E-Cu) Plated Copper
Plating : Minimum 3 microns (µm) Tin Plated



Malzeme: Bakır, Kalay Kaplı
Material: Copper, Tin Plated
İzolasyon / Isolation PA66

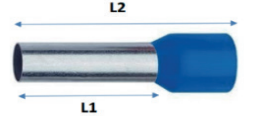

İzoleli Kablo Yüksükleri

Insulated End Sleeves

Ürün Kodu Product Code	Ürün Adı Product Name	Ölçüler Dimensions (mm)		Kesit Cross Sect. (mm ²)	AWG	Norm	Amb. Mik. Pack. Qty (Adet/Pcs.)	Birim Fiyatı Unit Price (TL/Adet)
		L1	L2					
8017335000	IES 0,50/8 Turuncu / Orange	8	12	0,5	20	Alman / German	1.000	0,520
8017335010	IES 0,75/8 Beyaz / White	8	14	0,75	18	Alman / German	1.000	0,520
8017335020	IES 1,0/8 Sarı / Yellow	8	14	1	17	Alman / German	1.000	0,546
8017335030	IES 1,5/8 Kırmızı / Red	8	14	1,5	16	Alman / German	1.000	0,598
8017335040	IES 2,5/8 Mavi / Blue	8	14	2,5	14	Alman / German	500	0,754
8017335050	IES 4,0/10 Gri / Grey	10	17	4	12	Alman / German	500	1,261
8017335060	IES 6,0/12 Siyah / Black	12	20	6	10	Alman / German	250	1,677
8017335070	IES 10,0/12 Fildişi / Ivory	12	22	10	8	Alman / German	100	2,340
8017335080	IES 16,0/12 Yeşil / Green	12	24	16	6	Alman / German	100	2,990
8017335090	IES 25,0/16 Kahve / Brown	16	28	25	4	Alman / German	50	5,590
8017335100	IES 35,0/16 Bej / Beige	16	30	35	2	Alman / German	50	6,500
8017335110	IES 50,0/20 Zeytin Yeşili / Olive Green	20	36	50	1	Alman / German	25	12,974

Ürün Kodu Product Code	Ürün Adı Product Name	Ölçüler Dimensions (mm)		Kesit Cross Sect. (mm ²)	AWG	Norm	Amb. Mik. Pack. Qty (Adet/Pcs.)	Birim Fiyatı Unit Price (TL/Adet)
		L1	L2					
8017335005	IES 0,50/8 Beyaz / White	8	12	0,5	20	Fransız / French	1.000	0,520
8017335015	IES 0,75/8 Mavi / Blue	8	14	0,75	18	Fransız / French	1.000	0,520
8017335025	IES 1,0/8 Kırmızı / Red	8	14	1	17	Fransız / French	1.000	0,546
8017335035	IES 1,5/8 Siyah / Black	8	14	1,5	16	Fransız / French	1.000	0,598
8017335045	IES 2,5/8 Gri / Grey	8	14	2,5	14	Fransız / French	500	0,754
8017335055	IES 4,0/10 Turuncu / Orange	10	17	4	12	Fransız / French	500	1,261
8017335065	IES 6,0/12 Yeşil / Green	12	20	6	10	Fransız / French	250	1,677
8017335075	IES 10,0/12 Kahve / Brown	12	22	10	8	Fransız / French	100	2,340
8017335085	IES 16,0/12 Bej / Beige	12	24	16	6	Fransız / French	100	2,990
8017335095	IES 25,0/16 Siyah / Black	16	28	25	4	Fransız / French	50	5,590
8017335105	IES 35,0/16 Kırmızı / Red	16	30	35	2	Fransız / French	50	6,500
8017335115	IES 50,0/20 Mavi / Blue	20	36	50	1	Fransız / French	25	12,974





Malzeme: Bakır, Kalay Kaplı
Material: Copper, Tin Plated
İzolasyon / Isolation PA66

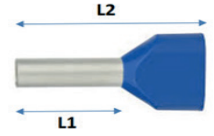

Çift Girişli Kablo Yüksükleri

Twin Cord End Sleeves

Ürün Kodu Product Code	Ürün Adı Product Name	Ölçüler Dimensions (mm)		Kesit Cross Sect. (mm ²)	Norm	Amb. Mik. Pack. Qty (Adet/Pcs.)	Birim Fiyatı Unit Price (TL/Adet)
		L1	L2				
8017335400	IES 2x0,50/8 Turuncu / Orange	8	14	2 x 0,5	Alman / German	1.000	0,962
8017335410	IES 2x0,75/8 Beyaz / White	8	14	2 x 0,75	Alman / German	500	0,988
8017335420	IES 2x1,0/8 Sarı / Yellow	8	14	2 x 1,0	Alman / German	500	1,053
8017335430	IES 2x1,5/8 Kırmızı / Red	8	14	2 x 1,5	Alman / German	500	1,287
8017335440	IES 2x2,5/10 Mavi / Blue	10	14	2 x 2,5	Alman / German	250	2,093
8017335450	IES 2x4,0/12 Gri / Grey	12	17	2 x 4,0	Alman / German	200	2,444
8017335460	IES 2x6,0/14 Siyah / Black	14	20	2 x 6,0	Alman / German	100	3,159
8017335470	IES 2x10,0/14 Fildişi / Ivory	14	27	2 x 10	Alman / German	50	4,836
8017335480	IES 2x16,0/14 Yeşil / Green	14	31	2 x 16	Alman / German	50	6,682

Ürün Kodu Product Code	Ürün Adı Product Name	Ölçüler Dimensions (mm)		Kesit Cross Sect. (mm ²)	Norm	Amb. Mik. Pack. Qty (Adet/Pcs.)	Birim Fiyatı Unit Price (TL/Adet)
		L1	L2				
8017335405	IES 2x0,50/8 Beyaz / White	8	14	2 x 0,5	Fransız / French	1.000	0,962
8017335415	IES 2x0,75/8 Mavi / Blue	8	14	2 x 0,75	Fransız / French	500	0,988
8017335425	IES 2x1,0/8 Kırmızı / Red	8	14	2 x 1,0	Fransız / French	500	1,053
8017335435	IES 2x1,5/8 Siyah / Black	8	14	2 x 1,5	Fransız / French	500	1,287
8017335445	IES 2x2,5/10 Gri / Grey	10	14	2 x 2,5	Fransız / French	250	2,093
8017335455	IES 2x4,0/12 Turuncu / Orange	12	17	2 x 4,0	Fransız / French	200	2,444
8017335465	IES 2x6,0/14 Yeşil / Green	14	20	2 x 6,0	Fransız / French	100	3,159
8017335475	IES 2x10,0/14 Kahve / Brown	14	27	2 x 10	Fransız / French	50	4,836
8017335485	IES 2x16,0/14 Bej / Beige	14	31	2 x 16	Fransız / French	50	6,682



Malzeme: Bakır, Kalay Kaplı
Material: Copper, Tin Plated

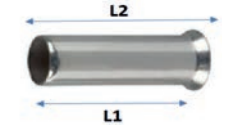

İzolesiz Kablo Yüksükleri

Non-insulated End Sleeves

Ürün Kodu Product Code	Ürün Adı Product Name	Ölçüler Dimensions (mm)		Kesit Cross Sect. (mm ²)	AWG	Amb. Mik. Pack. Qty (Adet/Pcs.)	Birim Fiyatı Unit Price (TL/Adet)
		L1	L2				
8017335220	ES 0,50/10	8	10	0,50	20	2.000	0,546
8017335230	ES 0,75/10	8	10	0,75	18	2.000	0,546
8017335240	ES 1,0/10	8	10	1,00	17	2.000	0,900
8017335250	ES 1,5/10	8	10	1,50	15	2.000	0,598
8017335260	ES 2,5/12	8	12	2,50	13	2.000	1,200
8017335270	ES 4,0/12	10	12	4,00	11	1.000	1,092
8017335280	ES 6,0/12	10	12	6,00	9	500	1,495
8017335290	ES 10,0/15	12	15	10,00	7	200	2,457
8017335300	ES 16,0/15	12	15	16,00	5	200	3,094
8017335310	ES 25,0/16	16	16	25,00	4	100	4,745
8017335320	ES 35,0/16	16	16	35,00	2	100	5,330
8017335330	ES 50,0/20	20	20	50,00	1	50	10,985



Malzeme: Bakır, Nikel Kaplı
Material: Copper, Nickel Plated
İzolasyon / Isolation PVC

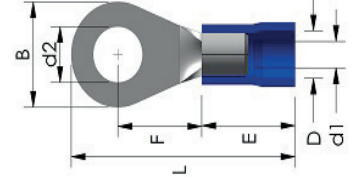

Yuvarlak Pabuçlar

Insulated Ring Terminals

Ürün Kodu Product Code	Ürün Adı Product Name	Kesit Cross Sect. (mm ²)	Ölçüler Dimensions (mm)							Renk Color	Amb. Mik. Pack. Qty (Adet/Pcs.)	Birim Fiyatı Unit Price (TL/Adet)
			d2	B	F	L	E	D	d1			
8018335500	IRT 301	0,5 - 1,5	3,2	5,5	4	16,7	10	4,1	1,7	Kırmızı / Red	200	1,690
8018335510	IRT 351	0,5 - 1,5	3,7	5,5	4	16,7	10	4,1	1,7	Kırmızı / Red	200	2,145
8018335520	IRT 401	0,5 - 1,5	4,3	6,6	6,3	19,6	10	4,1	1,7	Kırmızı / Red	200	2,522
8018335530	IRT 501	0,5 - 1,5	5,3	8	7	21	10	4,1	1,7	Kırmızı / Red	200	2,561
8018335540	IRT 601	0,5 - 1,5	6,5	11,6	11,1	26,8	10	4,1	1,7	Kırmızı / Red	200	4,030
8018335550	IRT 801	0,5 - 1,5	8,4	11,6	11,1	26,8	10	4,1	1,7	Kırmızı / Red	200	4,082
8018335560	IRT 302	1,5 - 2,5	3,2	6,4	4,3	17,5	10	4,5	2,3	Mavi / Blue	200	3,185
8018335570	IRT 402	1,5 - 2,5	4,3	6,6	6,3	19,5	10	4,5	2,3	Mavi / Blue	200	3,250
8018335580	IRT 502	1,5 - 2,5	5,3	8,5	7,8	22	10	4,5	2,3	Mavi / Blue	200	3,250
8018335590	IRT 602	1,5 - 2,5	6,5	12	11	27	10	4,5	2,3	Mavi / Blue	200	4,615
8018335600	IRT 802	1,5 - 2,5	8,4	12	11	27	10	4,5	2,3	Mavi / Blue	200	4,654
8018335610	IRT 1002	1,5 - 2,5	10,5	13,6	13,9	30,7	10	4,5	2,3	Mavi / Blue	100	4,719
8018335620	IRT 406	4,0 - 6,0	4,3	7,2	5,9	22	12,5	6,5	3,4	Sarı / Yellow	75	6,721
8018335630	IRT 506	4,0 - 6,0	5,3	9,5	8,3	25,5	12,5	6,5	3,4	Sarı / Yellow	75	6,747
8018335640	IRT 606	4,0 - 6,0	6,5	12	10,5	29	12,5	6,5	3,4	Sarı / Yellow	75	7,527
8018335650	IRT 806	4,0 - 6,0	8,4	15	13,7	33,7	12,5	6,5	3,4	Sarı / Yellow	75	9,724
8018335660	IRT 1006	4,0 - 6,0	10,5	15	13,7	33,7	12,5	6,5	3,4	Sarı / Yellow	75	9,646
8018335670	IRT 1206	4,0 - 6,0	13	19,2	16	38,1	12,5	6,5	3,4	Sarı / Yellow	75	9,867
8018335680	IRT 510	8,0 - 10,0	5,3	12	9,7	32,5	17	8	4,5	Kırmızı / Red	50	11,947
8018335690	IRT 610	8,0 - 10,0	6,7	12	9,7	32,5	17	8	4,5	Kırmızı / Red	50	12,974



Malzeme: Bakır, Nikel Kaplı
Material: Copper, Nickel Plated
İzolasyon / Isolation PVC

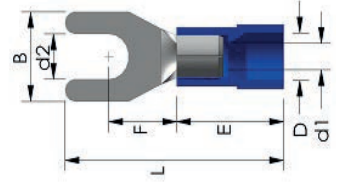

Çatal Pabuçlar

Insulated Fork Terminals

Ürün Kodu Product Code	Ürün Adı Product Name	Kesit Cross Sect. (mm ²)	Ölçüler Dimensions (mm)							Renk Color	Amb. Mik. Pack. Qty (Adet/Pcs.)	Birim Fiyatı Unit Price (TL/Adet)
			d2	B	F	L	E	D	d1			
8018335700	IFT 301	0,5 - 1,5	3,2	5,8	6,3	21	10	4,1	1,7	Kırmızı / Red	200	2,262
8018335720	IFT 401	0,5 - 1,5	4,3	6,4	6,3	20,6	10	4,1	1,7	Kırmızı / Red	200	2,353
8018335730	IFT 501	0,5 - 1,5	5,3	8	7	21	10	4,1	1,7	Kırmızı / Red	200	2,444
8018335740	IFT 601	0,5 - 1,5	6,5	12	11	27,2	10	4,1	1,7	Kırmızı / Red	200	2,756
8018335750	IFT 302	1,5 - 2,5	3,2	5,8	6,3	21	10	4,2	2,3	Mavi / Blue	200	2,496
8018335760	IFT 402	1,5 - 2,5	4,3	6,4	6,3	21	10	4,2	2,3	Mavi / Blue	200	2,587
8018335770	IFT 502	1,5 - 2,5	5,3	9,5	7,2	22	10	4,2	2,3	Mavi / Blue	200	2,587
8018335780	IFT 602	1,5 - 2,5	6,5	12	11	27,2	10	4,2	2,3	Mavi / Blue	200	3,484
8018335790	IFT 406	4,0 - 6,0	4,3	8,5	7,5	25,2	12,5	6,5	3,4	Sarı / Yellow	75	5,746
8018335800	IFT 506	4,0 - 6,0	5,3	9,5	7,5	25,2	12,5	6,5	3,4	Sarı / Yellow	75	5,863
8018335810	IFT 606	4,0 - 6,0	6,5	9,5	7,5	25,2	12,5	6,5	3,4	Sarı / Yellow	75	7,930
8018335820	IFT 806	4,0 - 6,0	8,4	13,5	10,5	30	12,5	6,5	3,4	Sarı / Yellow	75	8,944



Malzeme: Bakır, Pirinç Kaplı
Material: Copper, Brass Plated
İzolasyon / Isolation PVC

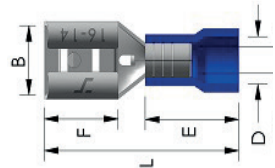

Faston Dişi Pabuçlar

Fast-on Female Terminals

Ürün Kodu Product Code	Ürün Adı Product Name	Kesit Cross Sect. (mm ²)	Ölçüler Dimensions (mm)					Renk Color	Amb. Mik. Pack. Qty (Adet/Pcs.)	Birim Fiyatı Unit Price (TL/Adet)
			B	F	L	E	D			
8018336030	FFT 1288	0,5 - 1,5	3,2	6,4	18,8	10	3,5	Kırmızı / Red	200	1,768
8018336100	FFT 1488	0,5 - 1,5	5	6,4	19,2	10	3,5	Kırmızı / Red	200	2,210
8018336110	FFT 1638	0,5 - 1,5	6,6	7,2	20,8	10	3,5	Kırmızı / Red	200	2,860
8018336115	FFT 2288	1,5 - 2,5	5	6,4	19,2	10	4,2	Mavi / Blue	150	2,210
8018336120	FFT 2488	1,5 - 2,5	6,6	6,4	19,2	10	4,2	Mavi / Blue	150	2,535
8018336130	FFT 2638	1,5 - 2,5	6,6	7,2	20,8	10	4,2	Mavi / Blue	150	2,925
8018336140	FFT 5638	4,0 - 6,0	6,6	7,2	23,3	13	5,6	Sarı / Yellow	100	3,510



Malzeme: Bakır, Pirinç Kaplı
Material: Copper, Brass Plated
İzolasyon / Isolation PVC

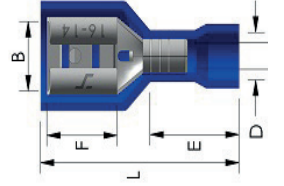

İzoleli Faston Dişi Pabuçlar

Insulated Fast-on Female Terminals

Ürün Kodu Product Code	Ürün Adı Product Name	Kesit Cross Sect. (mm ²)	Ölçüler Dimensions (mm)					Renk Color	Amb. Mik. Pack. Qty (Adet/Pcs.)	Birim Fiyatı Unit Price (TL/Adet)
			B	F	L	E	D			
8018336300	IFFT 1288	0,5 - 1,5	3,2	6,4	18,8	10	3,5	Kırmızı / Red	200	2,665
8018336310	IFFT 1488	0,5 - 1,5	5	6,4	19,2	10	3,5	Kırmızı / Red	200	2,925
8018336320	IFFT 1638	0,5 - 1,5	6,6	7,2	20,8	10	3,5	Kırmızı / Red	100	3,835
8018336325	IFFT 2288	1,5 - 2,5	3,2	6,4	20,0	10	4,2	Mavi / Blue	100	2,873
8018336330	IFFT 2488	1,5 - 2,5	5	6,4	19,2	10	4,2	Mavi / Blue	100	2,925
8018336340	IFFT 2638	1,5 - 2,5	6,6	7,2	20,8	10	4,2	Mavi / Blue	100	3,835
8018336350	IFFT 5638	4,0 - 6,0	6,6	7,2	23,8	13	5,6	Sarı / Yellow	75	4,225



Malzeme: Bakır, Pirinç Kaplı
Material: Copper, Brass Plated
İzolasyon / Isolation PVC

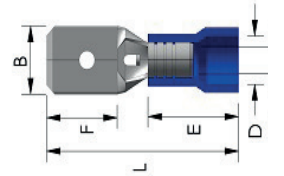

Faston Erkek Pabuçlar

Fast-on Male Terminals

Ürün Kodu Product Code	Ürün Adı Product Name	Kesit Cross Sect. (mm ²)	Ölçüler Dimensions (mm)					Renk Color	Amb. Mik. Pack. Qty (Adet/Pcs.)	Birim Fiyatı Unit Price (TL/Adet)
			B	F	L	E	D			
8018336150	FMT 1288	0,5 - 1,5	2,8	6,5	18,7	10	3,5	Kırmızı / Red	200	2,015
8018336160	FMT 1488	0,5 - 1,5	4,8	6,7	19,3	10	3,5	Kırmızı / Red	200	2,028
8018336170	FMT 1638	0,5 - 1,5	6,3	7,7	20,8	10	3,5	Kırmızı / Red	1200	2,405
8018336175	FMT 2288	1,5 - 2,5	2,8	6,7	19,3	10	4,2	Mavi / Blue	200	2,041
8018336180	FMT 2488	1,5 - 2,5	4,8	6,7	19,3	10	4,2	Mavi / Blue	200	2,041
8018336190	FMT 2638	1,5 - 2,5	6,3	7,7	20,8	10	4,2	Mavi / Blue	200	2,600
8018336200	FMT 5638	4,0 - 6,0	6,3	7,7	24	13	5,6	Sarı / Yellow	100	3,250



Malzeme: Bakır, Kalay Kaplı
Material: Copper, Tin Plated
İzolasyon / Isolation PVC

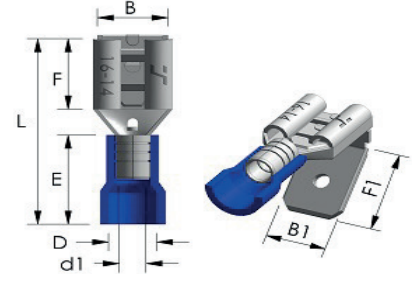

Geri Dönüşlü Pabuçlar

Piggy Back Terminals

Ürün Kodu Product Code	Ürün Adı Product Name	Kesit Cross Sect. (mm ²)	Ölçüler Dimensions (mm)								Renk Color	Amb. Mik. Pack. Qty (Adet/Pcs.)	Birim Fiyatı Unit Price (TL/Adet)
			B	B1	F	F1	L	E	D	d1			
8018336460	PBT 1638	0,5 - 1,5	6,6	6,3	8	8,2	22	10	3,5	1,7	Kırmızı / Red	100	4,940
8018336470	PBT 2638	1,5 - 2,5	6,6	6,3	8	8,2	22	10	4,2	2,3	Mavi / Blue	100	5,070
8018336480	PBT 5638	4,0 - 6,0	6,6	6,3	8	8,2	25	13	5,6	3,4	Sarı / Yellow	100	5,590



Malzeme: Bakır, Kalay Kaplı
Material: Copper, Tin Plated
İzolasyon / Isolation PVC

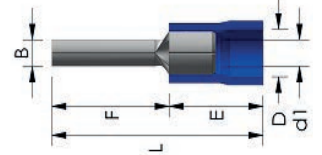

İğne Tip Pabuçlar

Insulated Pin Terminals

Ürün Kodu Product Code	Ürün Adı Product Name	Kesit Cross Sect. (mm ²)	Ölçüler Dimensions (mm)						Renk Color	Amb. Mik. Pack. Qty (Adet/Pcs.)	Birim Fiyatı Unit Price (TL/Adet)
			B	F	L	E	D	d1			
8018335900	IPT 1/1,5	0,5 - 1,5	1,9	12	22	10	4,3	1,7	Kırmızı / Red	200	2,665
8018335910	IPT 1/2,5	1,5 - 2,5	1,9	12	22	10	4,8	2,3	Mavi / Blue	200	3,185
8018335920	IPT 1/6	4,0 - 6,0	2,8	14	28	13	6,2	3,4	Sarı / Yellow	100	7,475



Malzeme: Bakır, Pirinç Kaplı
Material: Copper, Brass Plated
İzolasyon / Isolation PVC

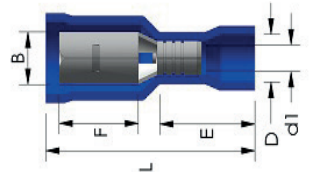

Dişi Pabuçlar

Bullet Female Terminals

Ürün Kodu Product Code	Ürün Adı Product Name	Kesit Cross Sect. (mm ²)	Ölçüler Dimensions (mm)						Renk Color	Amb. Mik. Pack. Qty (Adet/Pcs.)	Birim Fiyatı Unit Price (TL/Adet)
			B	F	L	E	D	d1			
8018336600	BFT 1040	0,5 - 1,5	3,9	7,3	23,5	10	3,5	1,7	Kırmızı / Red	100	6,955
8018336610	BFT 2050	1,5 - 2,5	4,9	8,5	25	10	4,2	2,3	Mavi / Blue	100	7,670
8018336620	BFT 5050	4,0 - 6,0	4,9	8,5	28	13	5,6	3,4	Sarı / Yellow	50	9,750



Malzeme: Bakır, Pirinç Kaplı
Material: Copper, Brass Plated
İzolasyon / Isolation PVC

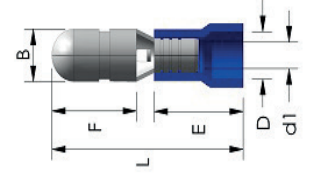

Erkek Pabuçlar

Bullet Male Terminals

Ürün Kodu Product Code	Ürün Adı Product Name	Kesit Cross Sect. (mm ²)	Ölçüler Dimensions (mm)						Renk Color	Amb. Mik. Pack. Qty (Adet/Pcs.)	Birim Fiyatı Unit Price (TL/Adet)
			B	F	L	E	D	d1			
8018336700	BMT 1040	0,5 - 1,5	4	8,5	21	10	3,5	1,7	Kırmızı / Red	100	5,850
8018336710	BMT 2050	1,5 - 2,5	5	9	21,5	10	4,2	2,3	Mavi / Blue	100	6,500
8018336720	BMT 5050	4,0 - 6,0	5	9	24,5	13	5,6	3,4	Sarı / Yellow	100	8,840



Malzeme: Bakır, Kalay Kaplı
Material: Copper, Tin Plated
İzolasyon / Isolation PVC

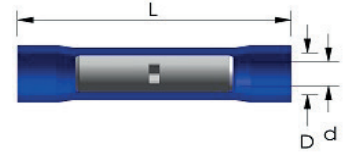

Ek Muflar

Insulated Butt Terminals

Ürün Kodu Product Code	Ürün Adı Product Name	Kesit Cross Sect. (mm ²)	Ölçüler Dimensions (mm)			Renk Color	Amb. Mik. Pack. Qty (Adet/Pcs.)	Birim Fiyatı Unit Price (TL/Adet)
			L	D	d			
8018336500	IBT 251	0,5 - 1,5	24,5	4,3	1,7	Kırmızı / Red	100	3,835
8018336510	IBT 252	1,5 - 2,5	24,5	4,8	2,3	Mavi / Blue	100	3,965
8018336520	IBT 256	4,0 - 6,0	27	6,2	3,4	Sarı / Yellow	100	6,435

Ledli Sinyal Lambaları - Ø22 mm

LED Indicators - Ø22 mm

Ürün Kodu Product Code	Ürün Adı Product Name	Nominal Gerilim Nominal Voltage (V)	Renk Color	Amb. Mik. Pack. Qty (Adet/Pcs.)	Birim Fiyatı Unit Price (TL/Adet)	
8026078912	SIL22-220 Kırmızı Sinyal Lambası Ledli	SIL22-220 Red Signal Lamp with LED	220V AC	●	25	74,100
8026078915	SIL22-220 Yeşil Sinyal Lambası Ledli	SIL22-220 Green Signal Lamp with LED	220V AC	●	25	74,100
8026078914	SIL22-220 Sarı Sinyal Lambası Ledli	SIL22-220 Yellow Signal Lamp with LED	220V AC	●	25	74,100
8026078916	SIL22-220 Mavi Sinyal Lambası Ledli	SIL22-220 Blue Signal Lamp with LED	220V AC	●	25	76,050
8026078919	SIL22-220 Beyaz Sinyal Lambası Ledli	SIL22-220 White Signal Lamp with LED	220V AC	○	25	76,050
8026078922	SIL22-220DC Kırmızı Sinyal Lambası Ledli	SIL22-220DC Red Signal Lamp with LED	220V DC	●	25	74,100
8026078925	SIL22-220DC Yeşil Sinyal Lambası Ledli	SIL22-220DC Green Signal Lamp with LED	220V DC	●	25	74,100
8026078924	SIL22-220DC Sarı Sinyal Lambası Ledli	SIL22-220DC Yellow Signal Lamp with LED	220V DC	●	25	74,100
8026078926	SIL22-220DC Mavi Sinyal Lambası Ledli	SIL22-220DC Blue Signal Lamp with LED	220V DC	●	25	76,050
8026078929	SIL22-220DC Beyaz Sinyal Lambası Ledli	SIL22-220DC White Signal Lamp with LED	220V DC	○	25	76,050
8026078932	SIL22-110 Kırmızı Sinyal Lambası Ledli	SIL22-110 Red Signal Lamp with LED	110V AC/DC	●	25	74,100
8026078935	SIL22-110 Yeşil Sinyal Lambası Ledli	SIL22-110 Green Signal Lamp with LED	110V AC/DC	●	25	74,100
8026078934	SIL22-110 Sarı Sinyal Lambası Ledli	SIL22-110 Yellow Signal Lamp with LED	110V AC/DC	●	25	74,100
8026078936	SIL22-110 Mavi Sinyal Lambası Ledli	SIL22-110 Blue Signal Lamp with LED	110V AC/DC	●	25	76,050
8026078939	SIL22-110 Beyaz Sinyal Lambası Ledli	SIL22-110 White Signal Lamp with LED	110V AC/DC	○	25	76,050
8026078942	SIL22-24 Kırmızı Sinyal Lambası Ledli	SIL22-24 Red Signal Lamp with LED	24V AC/DC	●	25	74,100
8026078945	SIL22-24 Yeşil Sinyal Lambası Ledli	SIL22-24 Green Signal Lamp with LED	24V AC/DC	●	25	74,100
8026078944	SIL22-24 Sarı Sinyal Lambası Ledli	SIL22-24 Yellow Signal Lamp with LED	24V AC/DC	●	25	74,100
8026078946	SIL22-24 Mavi Sinyal Lambası Ledli	SIL22-24 Blue Signal Lamp with LED	24V AC/DC	●	25	76,050
8026078949	SIL22-24 Beyaz Sinyal Lambası Ledli	SIL22-24 White Signal Lamp with LED	24V AC/DC	○	25	76,050



SIL22-24 Beyaz/White

SIL22-24 Kırmızı/Red

SIL22-220 Mavi/Blue

SIL22-220 Sarı/Yellow

SIL22-220 Yeşil/Green

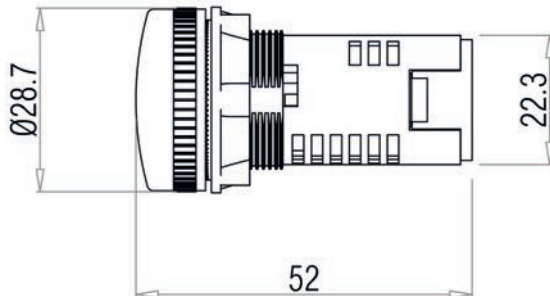

Yaylı Kumanda Butonları - Ø22 mm

Push Buttons Spring Return - Ø22 mm

Ürün Kodu Product Code	Ürün Adı Product Name	Kontakt Contact	Renk Color	Amb. Mik. Pack. Qty (Adet/Pcs.)	Birim Fiyatı Unit Price (TL/Adet)
8025078002	PSR-1C Kırmızı Düz Yaylı Tip 1 NK	1 NK	Red	15	120,900
8025078075	PSR-10 Yeşil Düz Yaylı Tip 1 NA	1 NA	Green	15	120,900
8025078104	PSR-10 Sarı Düz Yaylı Tip 1 NA	1 NA	Yellow	15	120,900
8025078106	PSR-10 Mavi Düz Yaylı Tip 1 NA	1 NA	Blue	15	120,900
8025078109	PSR-10 Beyaz Düz Yaylı Tip 1 NA	1 NA	White	15	120,900
8025078100	PSR-10 Siyah Düz Yaylı Tip 1 NA	1 NA	Black	15	120,900

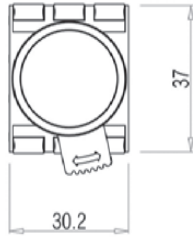
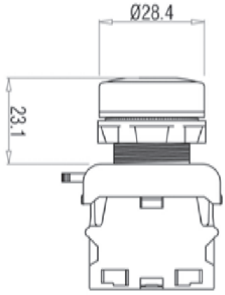

PSR-10 Sarı/Yellow



PSR-1C Kırmızı/Red



PSR-1C Yeşil/Green

Silikon Buton Koruma Kılıfı - Ø22 mm

Button Protection Cover - Ø22 mm

Ürün Kodu Product Code	Ürün Adı Product Name	Amb. Mik. Pack. Qty (Adet/Pcs.)	Birim Fiyatı Unit Price (TL/Adet)
8025078000	PSR-IP Şeffaf Silikon Buton Koruma Kılıfı	15	72,800



LED'li Yaylı Kumanda Butonları - Ø 22 mm

Push Buttons Spring Return LED - Ø 22 mm

Ürün Kodu Product Code	Ürün Adı Product Name	Nominal Gerilim (V) Nominal Voltage (V)	Renk Color	Amb. Mik. Pack. Qty (Adet/Pcs.)	Birim Fiyatı Unit Price (TL/Adet)
8025078022	PSRL-1C 220 Kırmızı Düz Yaylı Tip 1 NK Ledli	220 V AC/DC	●	15	227,500
8025078085	PSRL-1O 220 Yeşil Düz Yaylı Tip 1 NA Ledli	220 V AC/DC	●	15	227,500
8025078224	PSRL-1O 220 Sarı Düz Yaylı Tip 1 NA Ledli	220 V AC/DC	●	15	227,500
8025078226	PSRL-1O 220 Mavi Düz Yaylı Tip 1 NA Ledli	220 V AC/DC	●	15	227,500
8025078229	PSRL-1O 220 Beyaz Düz Yaylı Tip 1 NA Ledli	220 V AC/DC	○	15	227,500
8025078032	PSRL-1C 110 Kırmızı Düz Yaylı Tip 1 NK Ledli	110 V AC/DC	●	15	227,500
8025078095	PSRL-1O 110 Yeşil Düz Yaylı Tip 1 NA Ledli	110 V AC/DC	●	15	227,500
8025078234	PSRL-1O 110 Sarı Düz Yaylı Tip 1 NA Ledli	110 V AC/DC	●	15	227,500
8025078236	PSRL-1O 110 Mavi Düz Yaylı Tip 1 NA Ledli	110 V AC/DC	●	15	227,500
8025078239	PSRL-1O 110 Beyaz Düz Yaylı Tip 1 NA Ledli	110 V AC/DC	○	15	227,500
8025078042	PSRL-1C 48 Kırmızı Düz Yaylı Tip 1 NK Ledli	48 V AC/DC	●	15	227,500
8025078205	PSRL-1O 48 Yeşil Düz Yaylı Tip 1 NA Ledli	48 V AC/DC	●	15	227,500
8025078204	PSRL-1O 48 Sarı Düz Yaylı Tip 1 NA Ledli	48 V AC/DC	●	15	227,500
8025078206	PSRL-1O 48 Mavi Düz Yaylı Tip 1 NA Ledli	48 V AC/DC	●	15	227,500
8025078209	PSRL-1O 48 Beyaz Düz Yaylı Tip 1 NA Ledli	48 V AC/DC	○	15	227,500
8025078052	PSRL-1C 24 Kırmızı Düz Yaylı Tip 1 NK Ledli	24 V AC/DC	●	15	227,500
8025078215	PSRL-1O 24 Yeşil Düz Yaylı Tip 1 NA Ledli	24 V AC/DC	●	15	227,500
8025078214	PSRL-1O 24 Sarı Düz Yaylı Tip 1 NA Ledli	24 V AC/DC	●	15	227,500
8025078216	PSRL-1O 24 Mavi Düz Yaylı Tip 1 NA Ledli	24 V AC/DC	●	15	227,500
8025078219	PSRL-1O 24 Beyaz Düz Yaylı Tip 1 NA Ledli	24 V AC/DC	○	15	227,500

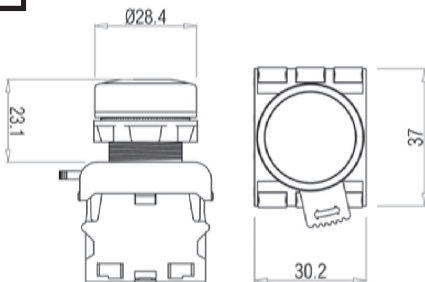

PSRL-1C Kırmızı/Red



PSRL-1O Yeşil/Green



PSRL-1O Mavi/Blue

Çiftli, Yaylı Kumanda Butonları - Ø 22 mm

Double Spring Push Button - Ø22 mm

Ürün Kodu Product Code	Ürün Adı Product Name		Kontakt Contact	Renk Color	Amb. Mik. Pack. Qty (Adet/Pcs.)	Birim Fiyatı Unit Price (TL/Adet)
8025078302	DSR-1C10 Çiftli Yaylı Tip 1NA+1NK	DSR-1C10 Double Spring Return 1NO+1NC	1 NA + 1 NK		10	188,500
8025078312	DSRL-1C10 220 Çiftli Yaylı Tip 1NA+1NK Ledli	DSRL-1C10 220 Double Spring Return 1NO+1NC with LED	1 NA + 1 NK		10	292,500
8025078362	DSRL-1C10 110 Çiftli Yaylı Tip 1NA+1NK Ledli	DSRL-1C10 110 Double Spring Return 1NO+1NC with LED	1 NA + 1 NK		10	292,500
8025078372	DSRL-1C10 24 Çiftli Yaylı Tip 1NA+1NK Ledli	DSRL-1C10 24 Double Spring Return 1NO+1NC with LED	1 NA + 1 NK		10	292,500

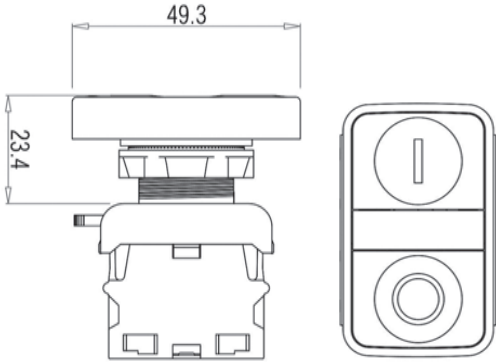

DSR-1C10

Acil Stop Kumanda Butonları - Ø 22 mm

Emergency Stop - Ø 22 mm

Ürün Kodu Product Code	Ürün Adı Product Name		Kontakt Contact	Renk Color	Amb. Mik. Pack. Qty (Adet/Pcs.)	Birim Fiyatı Unit Price (TL/Adet)
8025078012	EPB-1C Acil Stop 1 NK	EPB-1C Emergency Stop 1 NC	1 NK		10	149,500

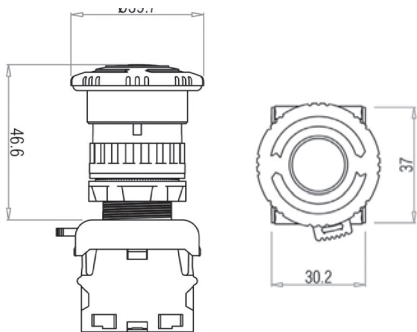

EPB-1C

Kalıcı Tip Seçici Butonlar - Ø 22 mm

Selector Switches Maintained - Ø22 mm

Ürün Kodu Product Code	Ürün Adı Product Name	Kontakt Contact	Renk Color	Pozisyon Position	Amb. Mik. Pack. Qty (Adet/Pcs.)	Birim Fiyatı Unit Price (TL/Adet)
8025078500	SSP-10 Kalıcı 0-1 Seçici Buton	1 NA	●	0 1	12	130,000
8025078510	SSP-20 Kalıcı 1-0-2 Seçici Buton	2 NA	●	1 0 2	12	172,900

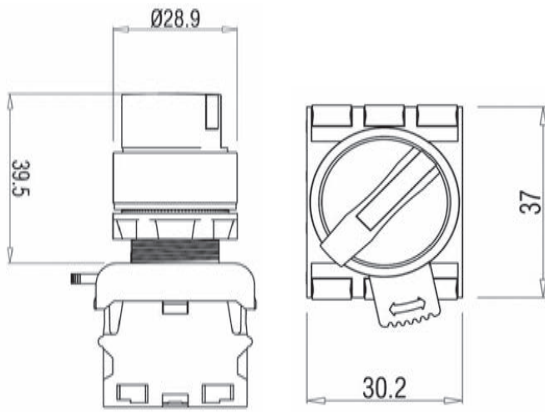

SSP-20

Yay Dönüslü Seçici Butonlar - Ø 22 mm

Selector Switch Momentary - Ø22 mm

Ürün Kodu Product Code	Ürün Adı Product Name	Kontakt Contact	Renk Color	Pozisyon Position	Amb. Mik. Pack. Qty (Adet/Pcs.)	Birim Fiyatı Unit Price (TL/Adet)
8025078320	SSM-10 Yay Dönüslü 0-1 Seçici Buton	1 NA	●	0 1	12	143,000
8025078330	SSM-20 Yay Dönüslü 1-0-2 Seçici Buton	2 NA	●	1 0 2	12	195,000

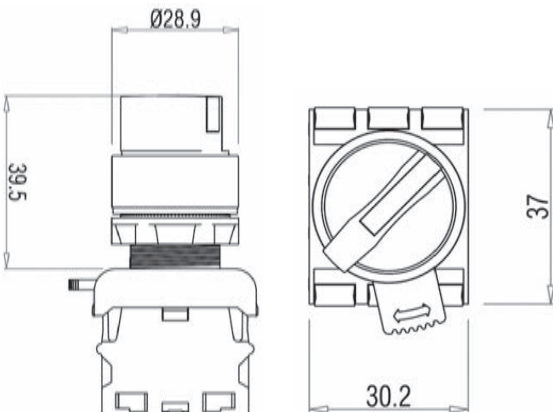

SMM-10

LED'li Kalıcı Tip Seçici Butonlar - Ø 22 mm

Selector Switches Maintained with LED - Ø22 mm

Ürün Kodu Product Code	Ürün Adı Product Name	Nominal Gerilim (V) Nominal Voltage (V)	Renk Color	Pozisyon Position	Amb. Mik. Pack. Qty (Adet/Pcs.)	Birim Fiyatı Unit Price (TL/Adet)
8025078602	SSP-10 220 L Kırmızı Kalıcı Işıklı 0-1 Seçici Buton SSP-10 220 L, 2 position 1NO 90° with LED	220 V AC/DC	Red	0 1	12	247,000
8025078605	SSP-10 220 L Yeşil Kalıcı Işıklı 0-1 Seçici Buton SSP-10 220 L, 2 position 1NO 90° with LED	220 V AC/DC	Green	0 1	12	247,000
8025078604	SSP-10 220 L Sarı Kalıcı Işıklı 0-1 Seçici Buton SSP-10 220 L, 2 position 1NO 90° with LED	220 V AC/DC	Yellow	0 1	12	247,000
8025078622	SSP-20 220 L Kırmızı Kalıcı Işıklı 1-0-2 Seçici Buton SSP-20 220 L, 3 position 1NO 60° with LED	220 V AC/DC	Red	1 0 2	12	292,500
8025078615	SSP-20 220 L Yeşil Kalıcı Işıklı 1-0-2 Seçici Buton SSP-20 220 L, 3 position 1NO 60° with LED	220 V AC/DC	Green	1 0 2	12	292,500
8025078614	SSP-20 220 L Sarı Kalıcı Işıklı 1-0-2 Seçici Buton SSP-20 220 L, 3 position 1NO 60° with LED	220 V AC/DC	Yellow	1 0 2	12	292,500

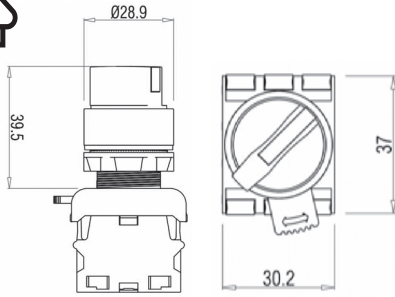

SSP-10 220 L Yeşil/Green



SSP-10 220 L Kırmızı/Red

LED'li Tip Yay Dönüştü Seçici Butonlar - Ø 22 mm

Selector Switch Momentary with LED - Ø22 mm

Ürün Kodu Product Code	Ürün Adı Product Name	Nominal Gerilim (V) Nominal Voltage (V)	Renk Color	Pozisyon Position	Amb. Mik. Pack. Qty (Adet/Pcs.)	Birim Fiyatı Unit Price (TL/Adet)
8025078402	SSM-10 220 L Kırmızı Yay Dönüştü Işıklı 0-1 Seçici Buton SSM-10 220 L, 1NO 90° with LED	220 V AC/DC	Red	0 1	12	231,400
8025078405	SSM-10 220 L Yeşil Yay Dönüştü Işıklı 0-1 Seçici Buton SSM-10 220 L, 2 position 1NO 90° with LED	220 V AC/DC	Green	0 1	12	231,400
8025078404	SSM-10 220 L Sarı Yay Dönüştü Işıklı 0-1 Seçici Buton SSM-10 220 L, 2 position 1NO 90° with LED	220 V AC/DC	Yellow	0 1	12	231,400
8025078422	SSM-20 220 L Kırmızı Yay Dönüştü Işıklı 1-0-2 Seçici Buton SSM-20 220 L, 3 position 2NC 60° with LED	220 V AC/DC	Red	1 0 2	12	295,100
8025078415	SSM-20 220 L Yeşil Yay Dönüştü Işıklı 1-0-2 Seçici Buton SSM-20 220 L, 3 position 2NO 60° with LED	220 V AC/DC	Green	1 0 2	12	295,100
8025078424	SSM-20 220 L Sarı Yay Dönüştü Işıklı 1-0-2 Seçici Buton SSM-20 220 L, 3 position 2NO 60° with LED	220 V AC/DC	Yellow	1 0 2	12	295,100

LED li Kalıcı ve Yaylı Tip Seçici Butonların 110V AC/DC ve 24V AC/DC Nominal Gerilimleri için lütfen satış temsilcinizle irtibata geçiniz.

Kontakt Blok Tipleri

Contact Block Types

Ürün Kodu Product Code	Ürün Adı Product Name	Kontakt Contact	Amb. Mik. Pack. Qty (Adet/Pcs.)	Birim Fiyatı Unit Price (TL/Adet)	
8025078800	CNT-O NA Kontakt	CNT-O NO Contact	1 NA	50	52,000
8025078810	CNT-C NK Kontakt	CNT-C NC Contact	1 NK	50	52,000
8025078820	CNT-S Işık Kontakt Blok	CNT-S Signal Contact	50	58,500	

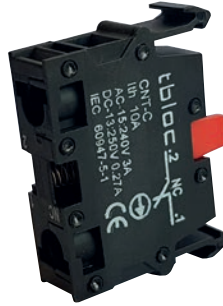
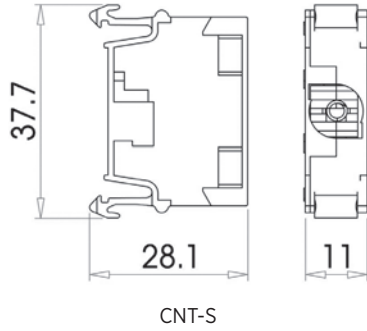
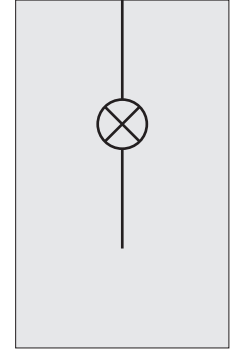
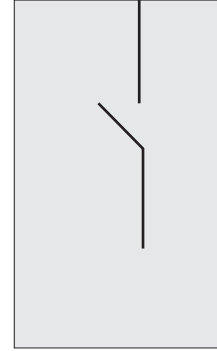
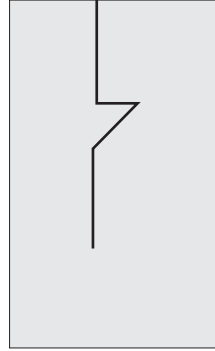
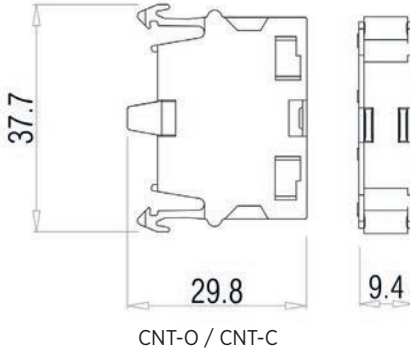

Teknik Bilgiler / Technical Information

Standart / Standard	IEC 60947-5-1
Çalışma Sıcaklığı min/maks. / Operating Temperature min/max (°C)	-5 / +40
Kirlilik Derecesi / Pollution Severity	3
Yalıtım Gerilimi / Rated insulation voltage (V)	400
Darbe Beyan Gerilimi / Rated impulse withstand voltage (kV)	4
Klasik Açık hava Termal Akım / Conventional Thermal Current (A)	10
Kullanım Sınıfı / Utilization Category	AC 15

Nominal Çalışma Gerilimi / Rated Operational Voltage (V)	Nominal Çalışma Akımı / Rated Operational Current (A)
380	1,9
240	3
120	6

ENDÜSTRİYEL ve PLC RÖLELER

İnce Tip Endüstriyel Röle
Kalın Tip Endüstriyel Röle
Vida Bağlantılı PLC Röle

Röle Soketi
Röle Tutucu, Ekstra Klipsler
Harici Led Modülleri
Markalama

INDUSTRIAL and INTERFACE RELAYS

Compact Industrial Relays
Plug-In Industrial Relays
Screw Type Interface Relay

Relay Socket
Relay Holder, Support Clips
External Led Modul
Marking



1CO 12A İnce Tip Endüstriyel Röle

Compact Industrial Relay



Ürün Kodu Product Code	Ürün Adı Product Name	Açıklama Explanation	Amb. Mik. Pack. Qty (Adet/Pcs.)	Birim Fiyatı Unit Price (USD/Adet)
8036311200	TRS LT-1C-12A-12 V DC	1CO, 12A, 12V DC, LED+Test Butonlu Kompakt Röle / Test Button Compact Relay	20	5,50
8036311210	TRS LT-1C-12A-24 V DC	1CO, 12A, 24V DC, LED+Test Butonlu Kompakt Röle / Test Button Compact Relay	20	5,50
8036311220	TRS LT-1C-12A-48 V DC	1CO, 12A, 48V DC, LED+Test Butonlu Kompakt Röle / Test Button Compact Relay	20	6,00
8036311230	TRS LT-1C-12A-110 V DC	1CO, 12A, 110V DC, LED+Test Butonlu Kompakt Röle / Test Button Compact Relay	20	7,00
8036311240	TRS LT-1C-12A-24 V AC	1CO, 12A, 24V AC, LED+Test Butonlu Kompakt Röle / Test Button Compact Relay	20	6,50
8036311270	TRS LT-1C-12A-230 V AC	1CO, 12A, 230V AC, LED+Test Butonlu Kompakt Röle / Test Button Compact Relay	20	7,00

2CO 8A İnce Tip Endüstriyel Röle

Compact Industrial Relay



Ürün Kodu Product Code	Ürün Adı Product Name	Açıklama Explanation	Amb. Mik. Pack. Qty (Adet/Pcs.)	Birim Fiyatı Unit Price (USD/Adet)
8036312800	TRS LT-2C-8A-12 V DC	2CO, 8A, 12V DC, LED+Test Butonlu Kompakt Röle / Test Button Compact Relay	20	6,50
8036312810	TRS LT-2C-8A-24 V DC	2CO, 8A, 24V DC, LED+Test Butonlu Kompakt Röle / Test Button Compact Relay	20	5,50
8036312820	TRS LT-2C-8A-48 V DC	2CO, 8A, 48V DC, LED+Test Butonlu Kompakt Röle / Test Button Compact Relay	20	7,00
8036312830	TRS LT-2C-8A-110 V DC	2CO, 8A, 110V DC, LED+Test Butonlu Kompakt Röle / Test Button Compact Relay	20	7,00
8036312840	TRS LT-2C-8A-24 V AC	2CO, 8A, 24V AC, LED+Test Butonlu Kompakt Röle / Test Button Compact Relay	20	6,50
8036312860	TRS LT-2C-8A-115 V AC	2CO, 8A, 115V AC, LED+Test Butonlu Kompakt Röle / Test Button Compact Relay	20	6,50
8036312870	TRS LT-2C-8A-230 V AC	2CO, 8A, 230V AC, LED+Test Butonlu Kompakt Röle / Test Button Compact Relay	20	7,00

Aksesuarlar

Accessories



Ürün Kodu Product Code	Ürün Adı Product Name	Açıklama Explanation	Amb. Mik. Pack. Qty (Adet/Pcs.)	Birim Fiyatı Unit Price (USD/Adet)
8036012000	TS-V TRS 1C	1 kontaklı soketi / 1C Relay Socket	20	4,00
8036012001	TS-V TRS 2C	2 kontaklı soketi / 2C Relay Socket	20	4,00
8036330100	MARK- TRS	Etiket (Röle ile birlikte set olarak verilmektedir) / Marking Tag (Arriving as set with relay)	20	0,10
8036330060	LED FC R 6-24 VAC/DC	Harici Led Modülü / External Led Modul	5	2,00
8036330000	CP- TRS	Plastik Röle Tutucu / Plastic Relay Holder	20	0,50
8036331003	JP TS-P-2C-8	TRS Serisi için 8 Kutuplu Köprü / 8 pole jumper for TRS Series	5	5,00

2CO 10A Kalın Tip Endüstriyel Röle

Plug-In Industrial Relay



Ürün Kodu Product Code	Ürün Adı Product Name	Açıklama Explanation	Amb. Mik. Pack. Qty (Adet/Pcs.)	Birim Fiyatı Unit Price (USD/Adet)
8036322010	TRB LT-2C-10A-24 V DC	2CO, 10A, 24V DC, LED+Test Butonlu Röle / Test Button Plug-In Industrial Relay	20	5,80
8036322020	TRB LT-2C-10A-48 V DC	2CO, 10A, 48V DC, LED+Test Butonlu Röle / Test Button Plug-In Industrial Relay	20	6,60
8036322030	TRB LT-2C-10A-110 V DC	2CO, 10A, 110V DC, LED+Test Butonlu Röle / Test Button Plug-In Industrial Relay	20	6,60
8036322040	TRB LT-2C-10A-24 V AC	2CO, 10A, 24V AC, LED+Test Butonlu Röle / Test Button Plug-In Industrial Relay	20	6,60
8036322050	TRB LT-2C-10A-48 V AC	2CO, 10A, 48V AC, LED+Test Butonlu Röle / Test Button Plug-In Industrial Relay	20	6,60
8036322060	TRB LT-2C-10A-115 V AC	2CO, 10A, 115V AC, LED+Test Butonlu Röle / Test Button Plug-In Industrial Relay	20	6,60
8036322070	TRB LT-2C-10A-230 V AC	2CO, 10A, 230V AC, LED+Test Butonlu Röle / Test Button Plug-In Industrial Relay	20	6,60

4CO 5A Kalın Tip Endüstriyel Röle

Plug-In Industrial Relay



Ürün Kodu Product Code	Ürün Adı Product Name	Açıklama Explanation	Amb. Mik. Pack. Qty (Adet/Pcs.)	Birim Fiyatı Unit Price (USD/Adet)
8036324500	TRB LT-4C-5A-12 V DC	4CO, 5A, 12V DC, LED+Test Butonlu Röle / Test Button Plug-In Industrial Relay	20	5,90
8036324510	TRB LT-4C-5A-24 V DC	4CO, 5A, 24V DC, LED+Test Butonlu Röle / Test Button Plug-In Industrial Relay	20	5,90
8036324520	TRB LT-4C-5A-48 V DC	4CO, 5A, 48V DC, LED+Test Butonlu Röle / Test Button Plug-In Industrial Relay	20	5,90
8036324530	TRB LT-4C-5A-110 V DC	4CO, 5A, 110V DC, LED+Test Butonlu Röle / Test Button Plug-In Industrial Relay	20	7,00
8036324540	TRB LT-4C-5A-24 V AC	4CO, 5A, 24V AC, LED+Test Butonlu Röle / Test Button Plug-In Industrial Relay	20	6,65
8036324550	TRB LT-4C-5A-48 V AC	4CO, 5A, 48V AC, LED+Test Butonlu Röle / Test Button Plug-In Industrial Relay	20	7,00
8036324560	TRB LT-4C-5A-115 V AC	4CO, 5A, 110V AC, LED+Test Butonlu Röle / Test Button Plug-In Industrial Relay	20	7,00
8036324570	TRB LT-4C-5A-230 V AC	4CO, 5A, 220V AC, LED+Test Butonlu Röle / Test Button Plug-In Industrial Relay	20	6,65

Aksesuarlar

Accessories



Ürün Kodu Product Code	Ürün Adı Product Name	Açıklama Explanation	Amb. Mik. Pack. Qty (Adet/Pcs.)	Birim Fiyatı Unit Price (USD/Adet)
8036024002	TS-V TRB 4C	2 & 4 Kontaklı Röle Soketi / 2C & 4C Relay Socket	10	4,50
8036330101	MARK- TRB	Etiket (Röle ile birlikte set olarak verilmektedir) / Marking Tag(Arriving as set with relay)	20	0,13
8036330060	LED FC R 6-24 VAC/DC	Harici Led Modülü / External Led Modul	5	2,00
8036330001	CP- TRB	Plastik Röle Tutucu / Plastic Relay Holder	20	0,50
8036331005	JP TS-P-4C-5	TRB Serisi için 5 Kutuplu Köprü / 5 pole jumper for TRS Series	5	5,00

Vida Bağlantılı 1CO PLC Röleler

Screw Type 1CO PLC Relays

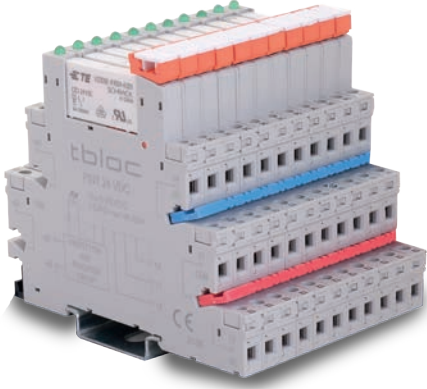

Ürün Kodu Product Code	Ürün Adı Product Name	Açıklama Explanation	Amb. Mik. Pack. Qty (Adet/Pcs.)	Birim Fiyatı Unit Price (USD/Adet)
8031241500	PINT-1C 24 V DC - 6A	1CO, 24V DC Röle + Soket / Relay and Socket	20	12,00
8031241510	PINT-1C 24 VAC/DC - 6A	1CO, 12-24V AC/DC Röle + Soket / Relay and Socket	20	12,00
8031241511	PINT-1C 60 VAC/DC - 6A	1CO, 48-60V AC/DC Röle + Soket / Relay and Socket	20	16,00
8031241512	PINT-1C 110 VAC/DC - 6A	1CO, 110-125V AC/DC Röle + Soket / Relay and Socket	20	16,00
8031241513	PINT-1C 230 VAC/DC - 6A	1CO, 220-240V AC/DC Röle + Soket / Relay and Socket	20	16,00

Vida Bağlantılı 2CO PLC Röleler

Screw Type 2CO PLC Relays



Ürün Kodu Product Code	Ürün Adı Product Name	Açıklama Explanation	Amb. Mik. Pack. Qty (Adet/Pcs.)	Birim Fiyatı Unit Price (USD/Adet)
8031241540	PINT-2C 24 V DC - 8A	2CO, 24V DC PLC Röle + Soket / Relay and Socket	20	24,00
8031241541	PINT-2C 12-24 VAC/DC - 8A	2CO, 12-24V AC/DC Röle + Soket / Relay and Socket	20	24,00
8031241542	PINT-2C 48-60 VAC/DC - 8A	2CO, 48-60V AC/DC Röle + Soket / Relay and Socket	20	28,00
8031241543	PINT-2C 110-125 VAC/DC - 8A	2CO, 110-125V AC/DC Röle + Soket / Relay and Socket	20	28,00
8031241544	PINT-2C 220-240 VAC/DC - 8A	2CO, 220-240V AC/DC Röle + Soket / Relay and Socket	20	28,00

Aksesuarlar

Accessories



Ürün Kodu Product Code	Ürün Adı Product Name	Açıklama Explanation	Amb. Mik. Pack. Qty (Adet/Pcs.)	Birim Fiyatı Unit Price (USD/Adet)
8031241533	PINT GİRİŞ ADAPTÖRÜ	PINT 1C Serisi PLC Röle Adaptör / Adaptor for PINT 1C PLC Relays	20	24,00

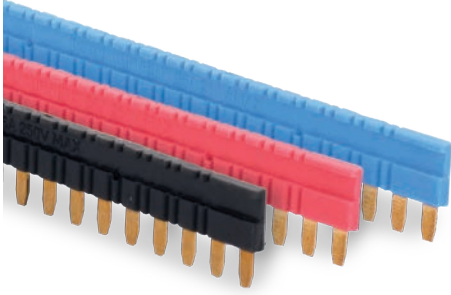

Ürün Kodu Product Code	Ürün Adı Product Name	Açıklama Explanation	Amb. Mik. Pack. Qty (Adet/Pcs.)	Birim Fiyatı Unit Price (USD/Adet)
8036331000	JP PINT-20-MAVİ	PINT 1C Serisi için 20 Kutuplu Köprü / 20 Pole jumper for PINT 1C (Blue)	5	5,00
8036331001	JP PINT-20-SİYAH	PINT 1C Serisi için 20 Kutuplu Köprü / 20 Pole jumper for PINT 1C (Black)	5	5,00
8036331002	JP PINT-20-KIRMIZI	PINT 1C Serisi için 20 Kutuplu Köprü / 20 Pole jumper for PINT 1C (Red)	5	5,00

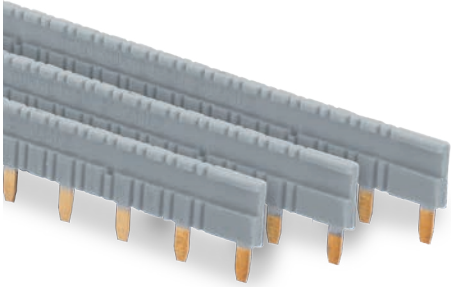

Ürün Kodu Product Code	Ürün Adı Product Name	Açıklama Explanation	Amb. Mik. Pack. Qty (Adet/Pcs.)	Birim Fiyatı Unit Price (USD/Adet)
8036331007	JP PINT-8-GRİ	PINT 2C Serisi için 8 Kutuplu Köprü / 8 Pole jumper for PINT 2C (Gray)	5	6,00

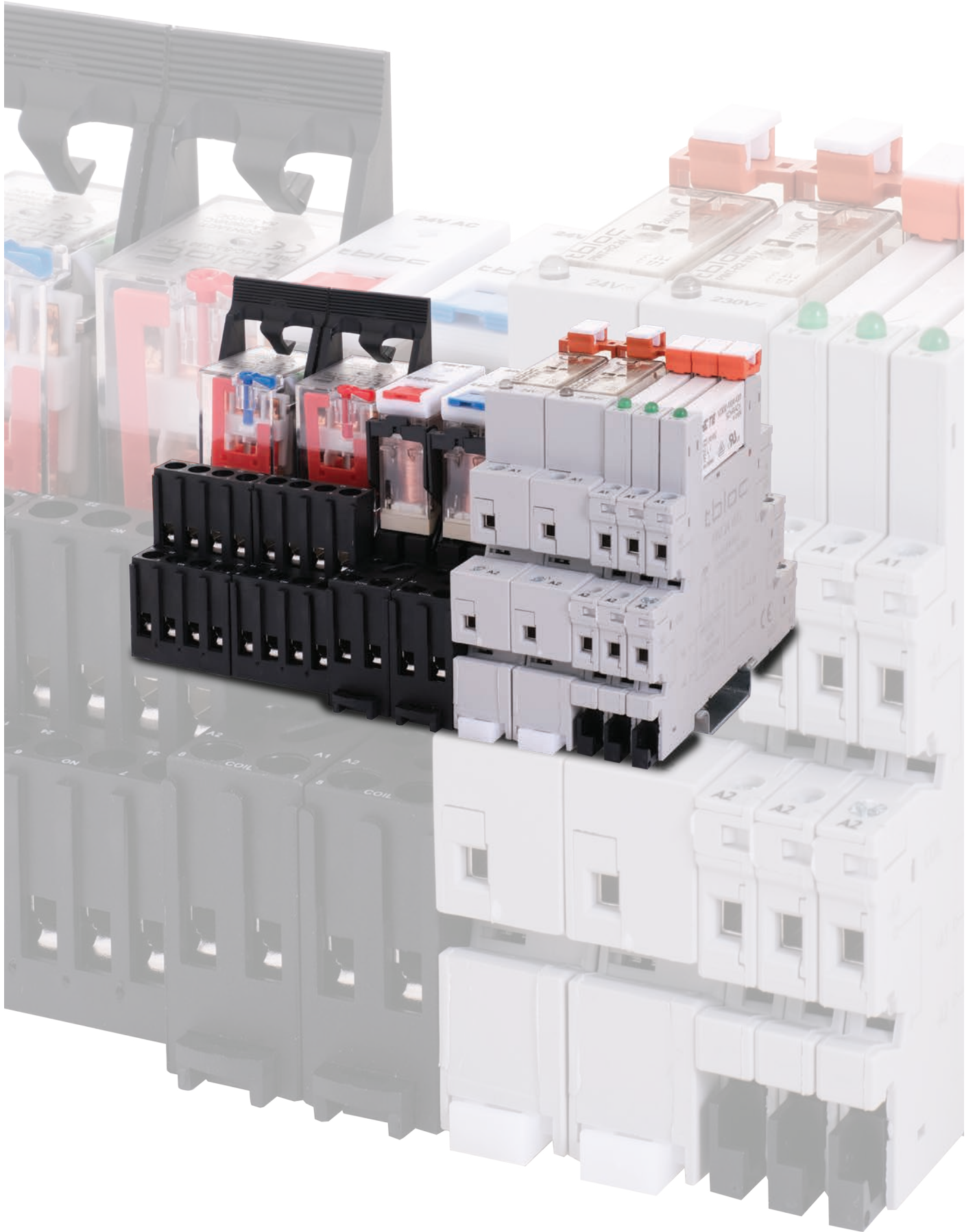

MERKEZ**Tbloc Elektrik Elektronik San. ve Tic. A.Ş.**

29 Ekim Mahallesi 10001 Sokak No: 50/4

35663 Menemen İzmir Turkey

Tel: +90 232 833 26 96

Fax: +90 232 833 26 97

İSTANBUL AVRUPA BÖLGE

Gsm: +90 539 599 20 45

E-mail: istanbulavrupa@tbloc.com.tr

İSTANBUL ANADOLU BÖLGE

Gsm: +90 539 599 20 45

E-mail: istanbulanadolu@tbloc.com.tr

EGE ve AKDENİZ BÖLGESİ

Gsm: +90 539 776 08 15

E-mail: egebolge@tbloc.com.tr

İÇ ANADOLU BÖLGE

Gsm: +90 539 599 18 02

E-mail: icanadolubolge@tbloc.com.tr

GÜNEY ANADOLU BÖLGE

Gsm: +90 539 334 94 48

E-mail: guneyanadolubolge@tbloc.com.tr

info@tbloc.com.tr

www.tbloc.com.tr

YETKİLİ SATICI

--